



## 2: INSTALLATION MANUAL

# NV5LT/NV3.5LT TRANSMITTER

Document ID:	NHB-NV3.5LT-NV5LT-INS
Version:	6.0
Issue Date:	2024-05-01
Status:	Standard





## Contact Information

### **Nautel Limited**

10089 Peggy's Cove Road  
Hackett's Cove, NS Canada B3Z 3J4

Toll Free: +1.877.6NAUTEL (662.8835)  
(Canada & USA only) or

Phone: +1.902.823.3900 or

Fax: +1.902.823.3183

### **Nautel Inc.**

201 Target Industrial Circle  
Bangor, Maine USA 04401

Phone: +1.207.947.8200

Fax: +1.207.947.3693

### **Customer Service (24-hour support)**

+1.877.628.8353 (Canada & USA only)

+1.902.823.5100 (International)

Email: [support@nautel.com](mailto:support@nautel.com)

Web: [www.nautel.com](http://www.nautel.com)

The comparisons and other information provided in this document have been prepared in good faith based on publicly available information. For verification of materials, the reader is encouraged to consult the respective manufacturer's most recent publication on the official website or through contact with Customer Service.

© Copyright 2024 NAUTEL. All rights reserved.



# CONTENTS

Contact Information	2.iii
<b>RELEASE CONTROL RECORD</b>	<b>2.IX</b>
<b>PREPARING FOR INSTALLATION</b>	<b>2.1.1</b>
<b>UNPACKING AND POSITIONING</b>	<b>2.2.1</b>
<b>INSTALLING OPTIONS</b>	<b>2.3.1</b>
Upgrading to Dual Exciter	2.3.2
Installing the UPS Interface	2.3.3
Redundant LVPS Upgrade	2.3.4
Installing the Remote Interface PWB	2.3.5
Installing the Orban Inside Card	2.3.6
<b>CONNECTING TO STATION REFERENCE GROUND</b>	<b>2.4.1</b>
<b>CONNECTING AC POWER</b>	<b>2.5.1</b>
<b>INSTALLING THE RF FEED CABLE</b>	<b>2.6.1</b>
<b>INSTALLING PROGRAM INPUTS</b>	<b>2.7.1</b>
Planning Complete?	2.7.1
Routing Cables	2.7.1
<b>INSTALLING CONTROL/MONITOR WIRING</b>	<b>2.8.1</b>
Planning Complete?	2.8.1
Routing Cables	2.8.1

<b>COMMISSIONING</b>	<b>2.9.1</b>
Pre-Commissioning Tasks	2.9.2
Commissioning	2.9.3
Turning on the Transmitter	2.9.3
Going On-Air	2.9.8
Network Setup	2.9.9
Configuring an External UPS	2.9.11
<hr/>	
<b>PARTS AND TOOLS</b>	<b>2.10.1</b>
Contacting Nautel	2.10.1
Parts Supplied by Nautel	2.10.2
Ancillary Parts Kit	2.10.2
Documentation	2.10.2
Parts Not Supplied by Nautel	2.10.2
Parts Ordering	2.10.2
Module Exchange Program	2.10.3
Tools for Installation	2.10.3
<hr/>	
<b>PRE-INSTALLATION / INSTALLATION ASSISTANCE</b>	<b>2.11.1</b>
Pre-Installation Consulting	2.11.1
Installation and Commissioning Service	2.11.1
Online Documentation	2.11.2
On-Site Support	2.11.3
Training	2.11.3
Standard Warranty	2.11.4
Technical Assistance	2.11.6
Module Exchange Service	2.11.6
Extended Warranties	2.11.7
Coverage	2.11.7
Details	2.11.7
Purchasing a One or Two-Year Extended Warranty Plan	2.11.8

---

Using the Extended Warranty Plan

2.11.8

---

LIST OF TERMS

2.12.1





## Release Control Record

ISSUE	DATE	REASON
6.0	2024-05-01	Release 6 of NV5LT/NV3.5LT (NARF71F/01). Supports software version NVLT SW 5.0 or newer.



## SECTION 2.1: PREPARING FOR INSTALLATION

Before installing your NV5LT/NV3.5LT transmitter, perform the following steps:

1. Ensure that you have performed the pre-installation tasks described in the NV5LT/NV3.5LT Pre-installation Manual.
2. Make sure that you received all the components. Check your packing list.
3. Inspect all crates and packages for damage. Monitor the tip and drop indicators attached to the crates to determine if a crate has been tipped over or has been subjected to excessive shock (see [Figure 2.1.1](#)).

Figure 2.1.1: Tip and drop indicators



4. Report any damage immediately to your Nautel sales representative and the carrier.
5. Move the crates as close as possible to the transmitter's planned location.
6. Unpack the crates in accordance with the instructions provided on the outside of the crates.
  - ❖ For each crate, remove the panel labelled **open this side**. The panel is attached using Phillips head screws.
  - ❖ Remove any visible packing material, including braces, from the crate's interior.
  - ❖ Remove the lag bolts on the bottom edge of the remaining three sides, leaving only the transmitter and its support pallet.

7. Review any assembly notes or instructions contained inside the transmitter crates. (For sites requiring custom configurations, the instructions provided with the transmitter replace the instructions provided here.)
8. Assemble your parts and tools. For a list of required tools, see [“Parts and Tools”](#) on page 2.10.1.
9. When you are ready to install the NV5LT/NV3.5LT transmitter, follow the steps shown in [Figure 2.1.2](#).

**TIP**      When you have completed a task or step, put a check mark beside the step number.

**CAUTION!** FAILURE TO COMPLY WITH RECOMMENDATIONS MAY VOID YOUR MANUFACTURER’S WARRANTY. FOR MORE INFORMATION, REVIEW YOUR WARRANTY DOCUMENT.

*Figure 2.1.2: Flowchart - Installing the transmitter*

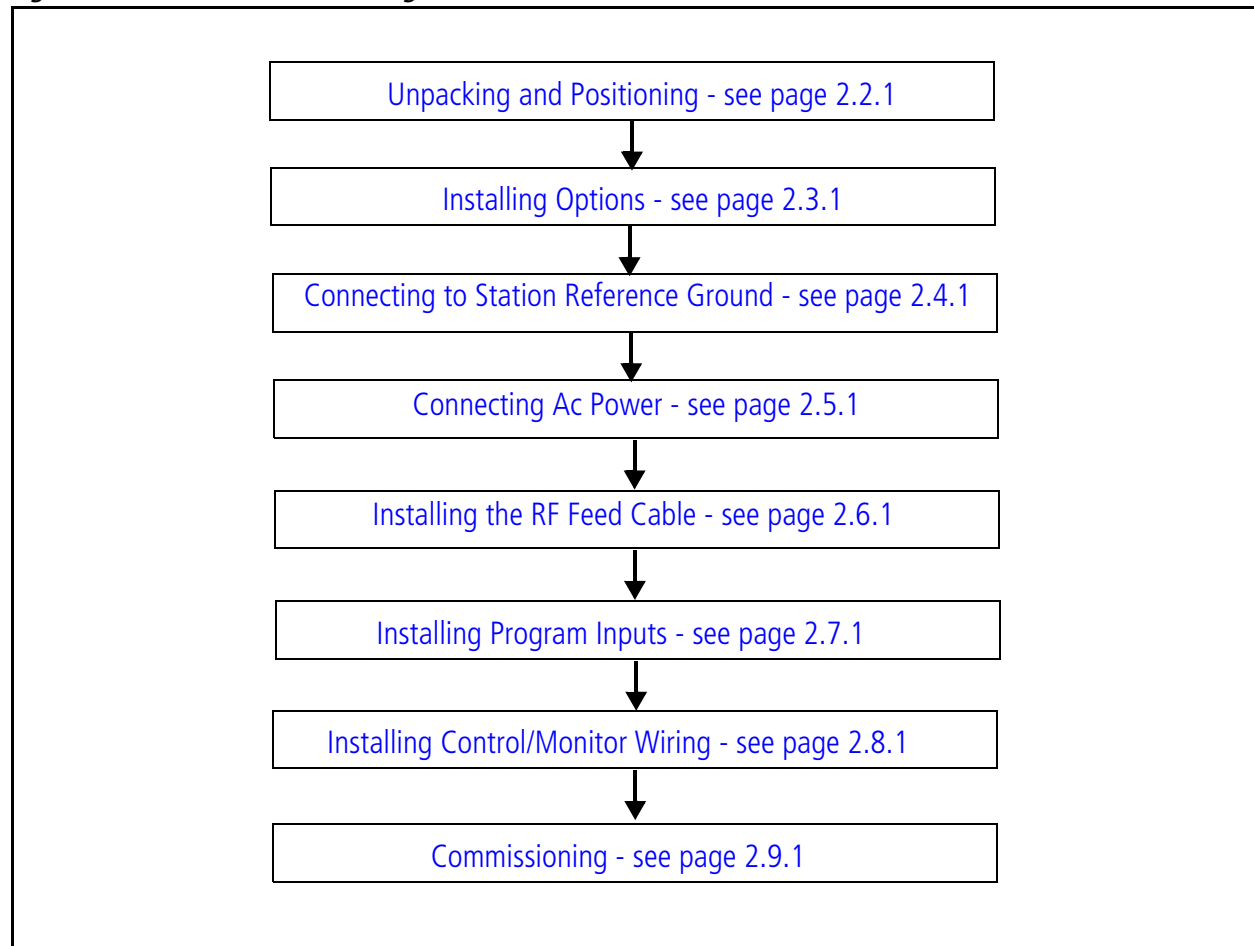

## SECTION 2.2: UNPACKING AND POSITIONING

To install an NV5LT/NV3.5LT transmitter, perform the following tasks:

1. Lift and slide the transmitter cabinet off the base of its crate. Crated and uncrated cabinet weights are shown in [Table 2.2.1](#).

**WARNING! DO NOT ATTEMPT TO MOVE THE TRANSMITTER UNLESS SUFFICIENT MANPOWER OR MECHANICAL ASSISTANCE IS AVAILABLE TO MOVE IT INTO POSITION WITHOUT DAMAGING THE CABINET OR CAUSING INJURY TO PERSONNEL.**

*Table 2.2.1: NV5LT/NV3.5LT Cabinet Weights*

CABINET	CRATED WEIGHT	UNCRADED WEIGHT
Transmitter Cabinet	279 kg (615 lbs)	151 kg (333 lbs)

2. Using necessary mechanical assistance (forklift, etc.), position the cabinet in its final location. If the transmitter needs to pass through a doorway that is less than 31.0 in. (78.8 cm) wide, you must remove the transmitter's rear filter panel (secured with 1/4 turn fasteners). You can also remove the front hinged UI panel to reduce the transmitter depth below 30 in. (76.2 cm).
3. Obtain the operating system (OS) password document which is attached to the Exciter handle, located inside the lower front panel. Store in a safe place for future reference.
4. Remove the transmitter's rear panels to allow access to customer input wiring. This may have already been done in [Step 2](#). See [Figure 2.2.1 on page 2.2.3](#) to see access panels. If you are anchoring your transmitter against seismic activity, obtain four 2-1/4 inch square washers (Nautel Part # HPS30) from the ancillary kit. Position the transmitter over four pre-drilled mounting holes and install four anchoring bolts (user-provided), with square washers, in the holes provided in the bottom of the transmitter cabinet (see [Figure 2.2.2 on page 2.2.4](#)). It is possible to drill through the hole plugs in the bottom of the transmitter, without removing them.
5. As desired, remove the M8 shipping screws in the back of each RF power module (see [Figure 2.2.3 on page 2.2.5](#)). Nautel recommends you remove these screws, unless your site experiences seismic activity.

- 
6. Install the RF output connector, which was partially disassembled for shipment, as follows (see [Figure 2.2.4 on page 2.2.6](#) through [Figure 2.2.6 on page 2.2.8](#)):

**NOTE:** The RF output connector was factory configured prior to shipping for the desired EIA connector (1-5/8 inch, 3-1/8 inch or 7/8 inch).

- ❖ Remove the output cover packing plate from the RF output connector on top of the transmitter. The packing plate - along with two spacer plates - is secured using four M6 screws. Remove only the packing plate, leave the spacer plates in place and retain the screws.
- ❖ Obtain the Output Stud Plate, which was packaged with the ancillaries. If unable to locate the output stud plate in the ancillaries, it may have been tyrapped to rear of transmitter due to space restrictions. Using the M6 screws retained above, install the output stud plate on top of the spacer plates. Firmly tighten M6 hardware. Note that the output stud plate's studs contain the necessary securing hardware (nuts, flat washers and split washers) to connect the RF output to a dummy load or the antenna system in [Section 2.9, "Commissioning"](#).

**NOTE:** For 7/8 inch EIA connectors (see [Figure 2.2.5 on page 2.2.7](#)), note that the 7/8 inch adapter (Nautel part number JS59) is found in the ancillary kit.

7. Verify that the RF feed cable reaches the RF output connector on the top of the cabinet. The RF feed cable will be connected in [Section 2.6, "Installing the RF Feed Cable"](#).
8. Proceed to [Section 2.3, "Installing Options"](#) to configure your transmitter for any options that were purchased.
9. Do not re-install the rear panels at this time.

Figure 2.2.1: Front and Rear Access Panels

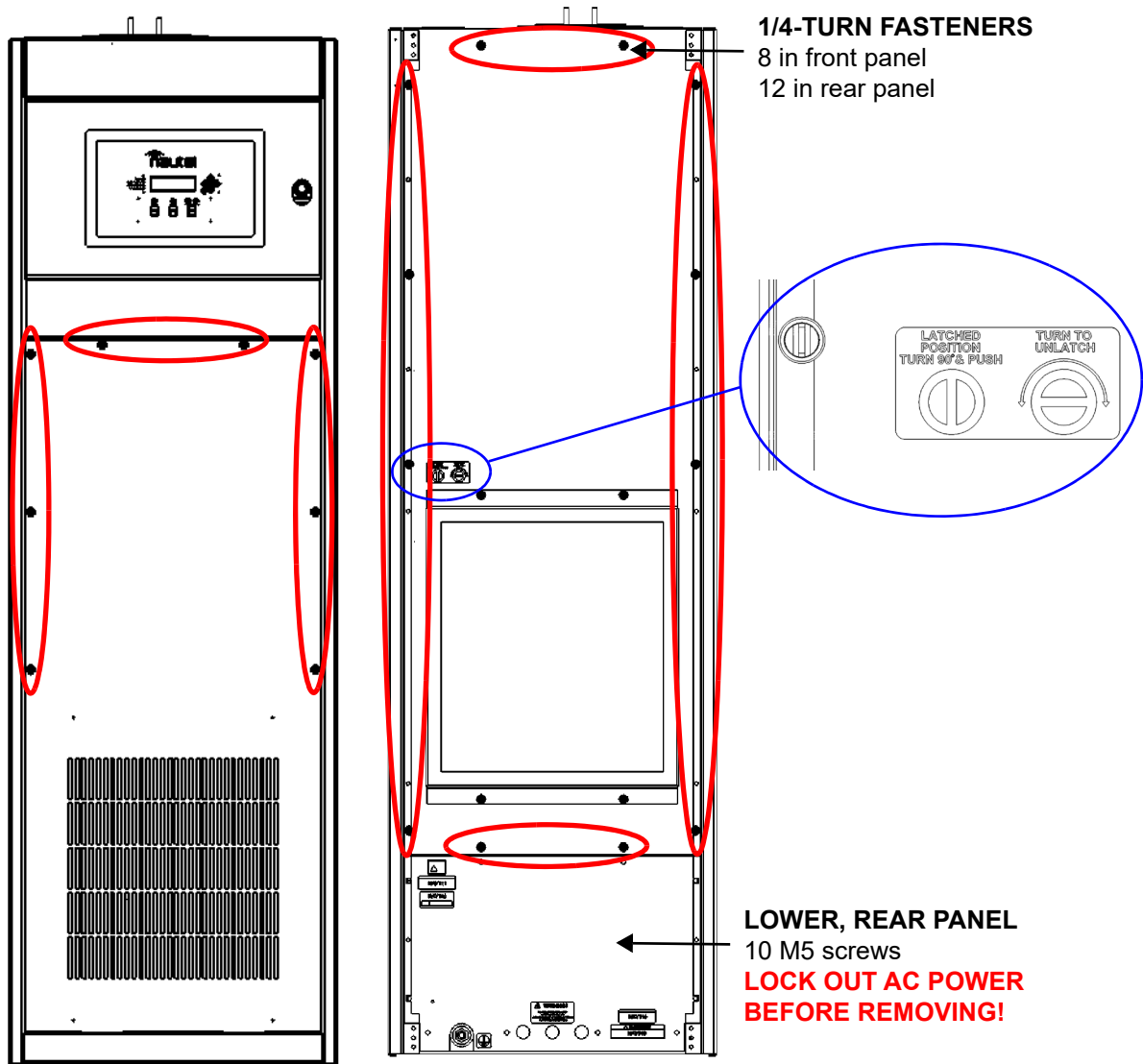

Figure 2.2.2: Seismic Anchoring Hole Locations

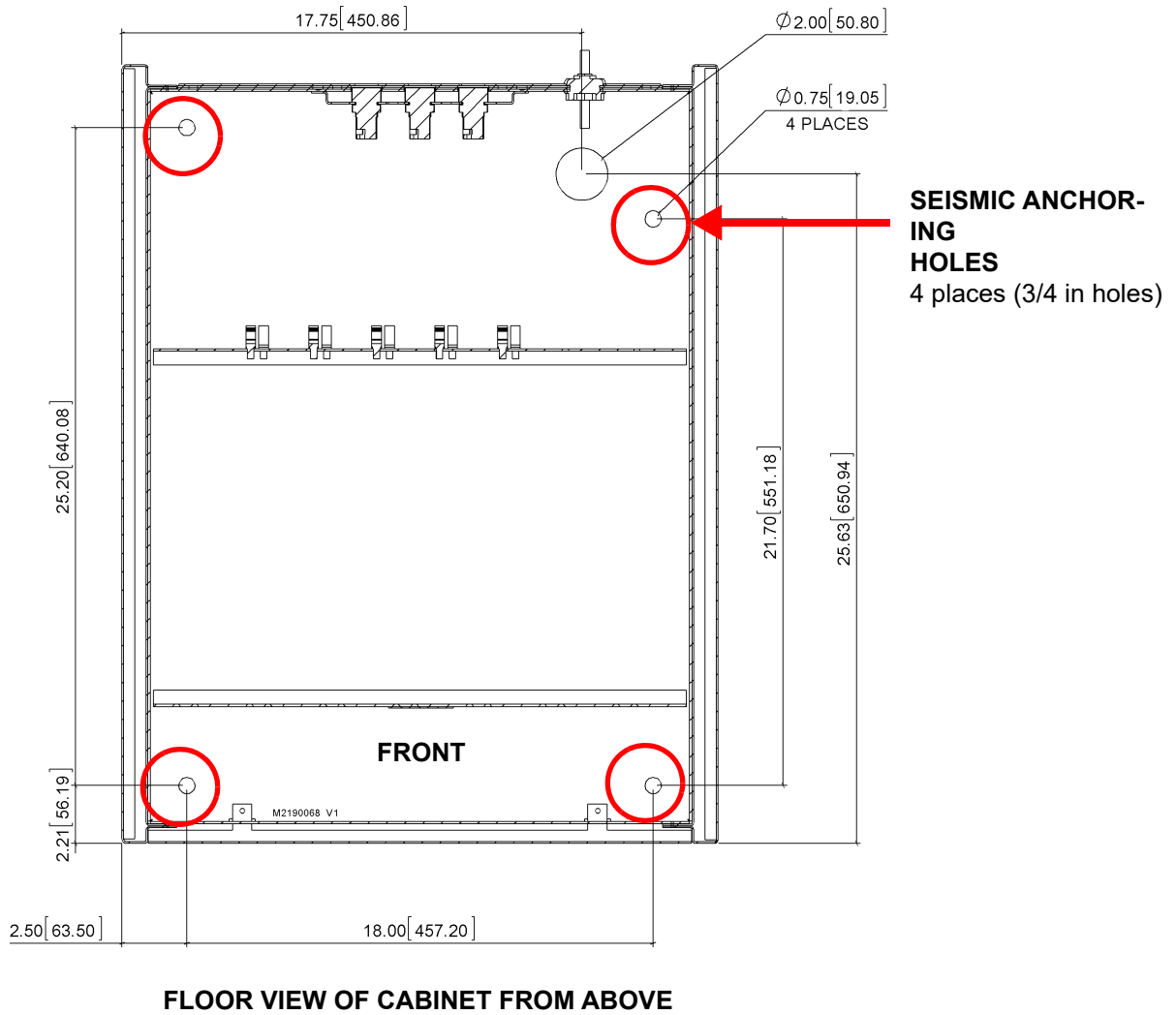



Figure 2.2.3: RF Power Module Shipping Bolts

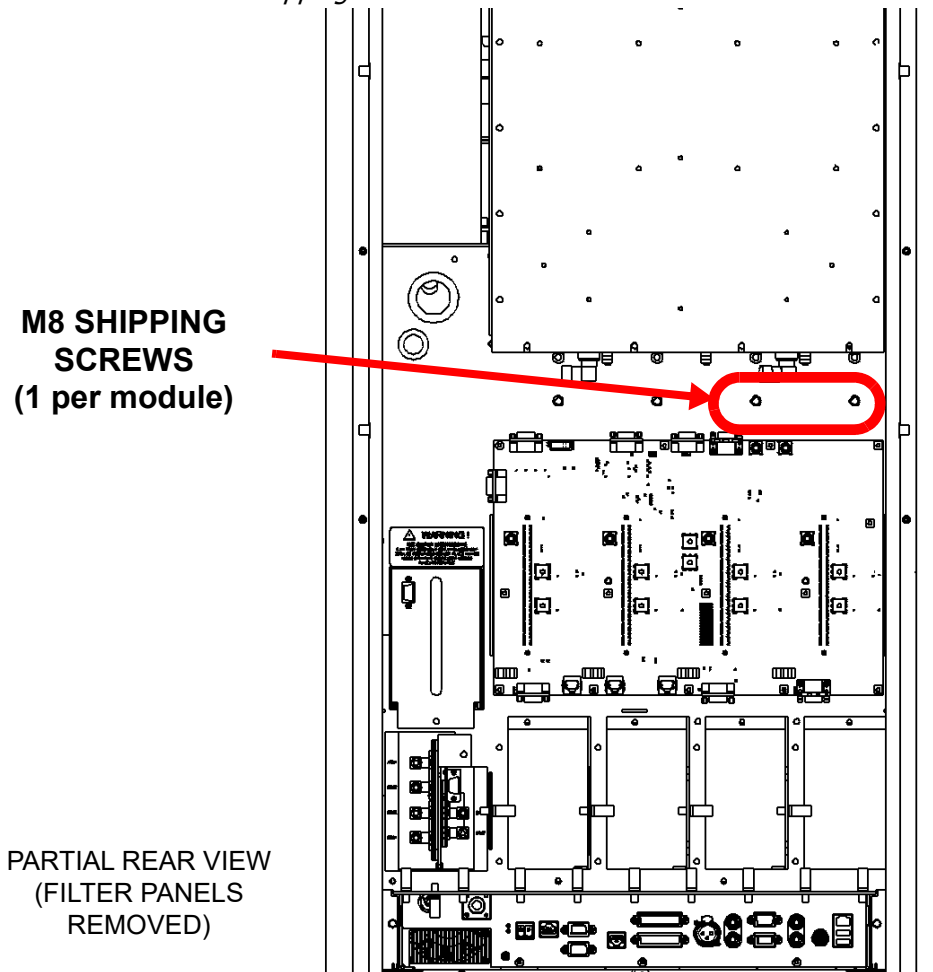

Figure 2.2.4: RF Output Connector Assembly Detail - 1-5/8 inch EIA (Standard)

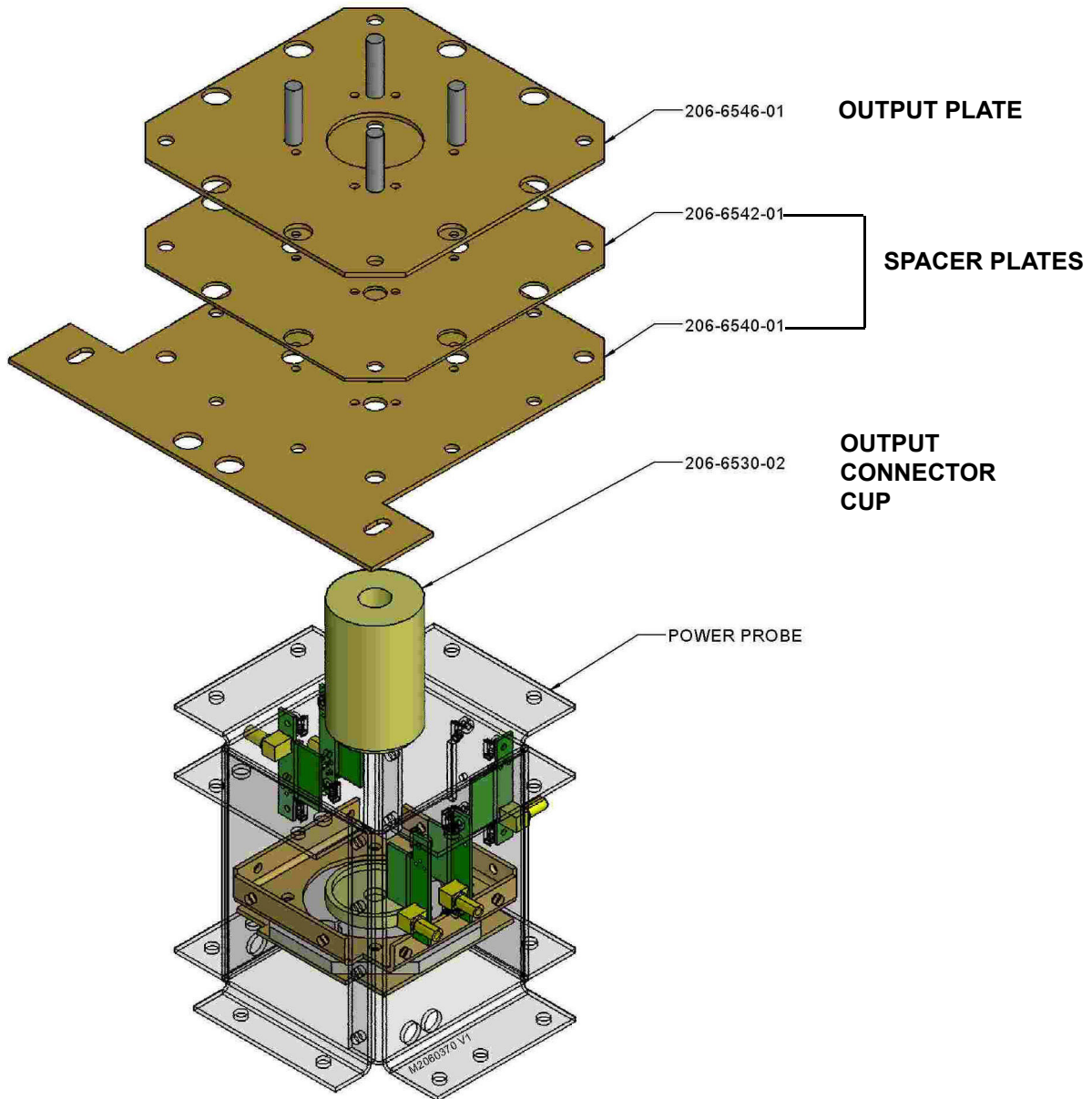
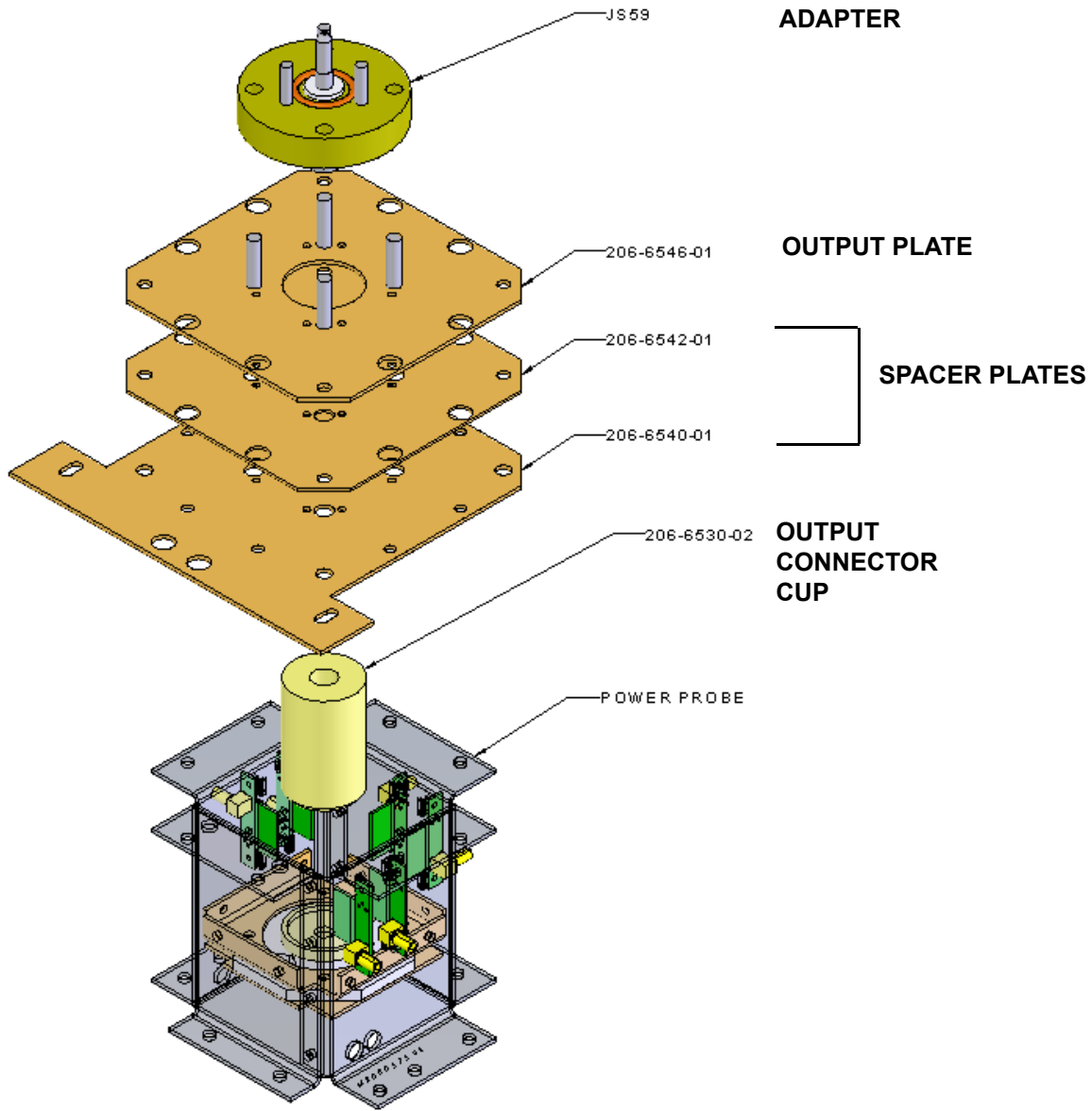
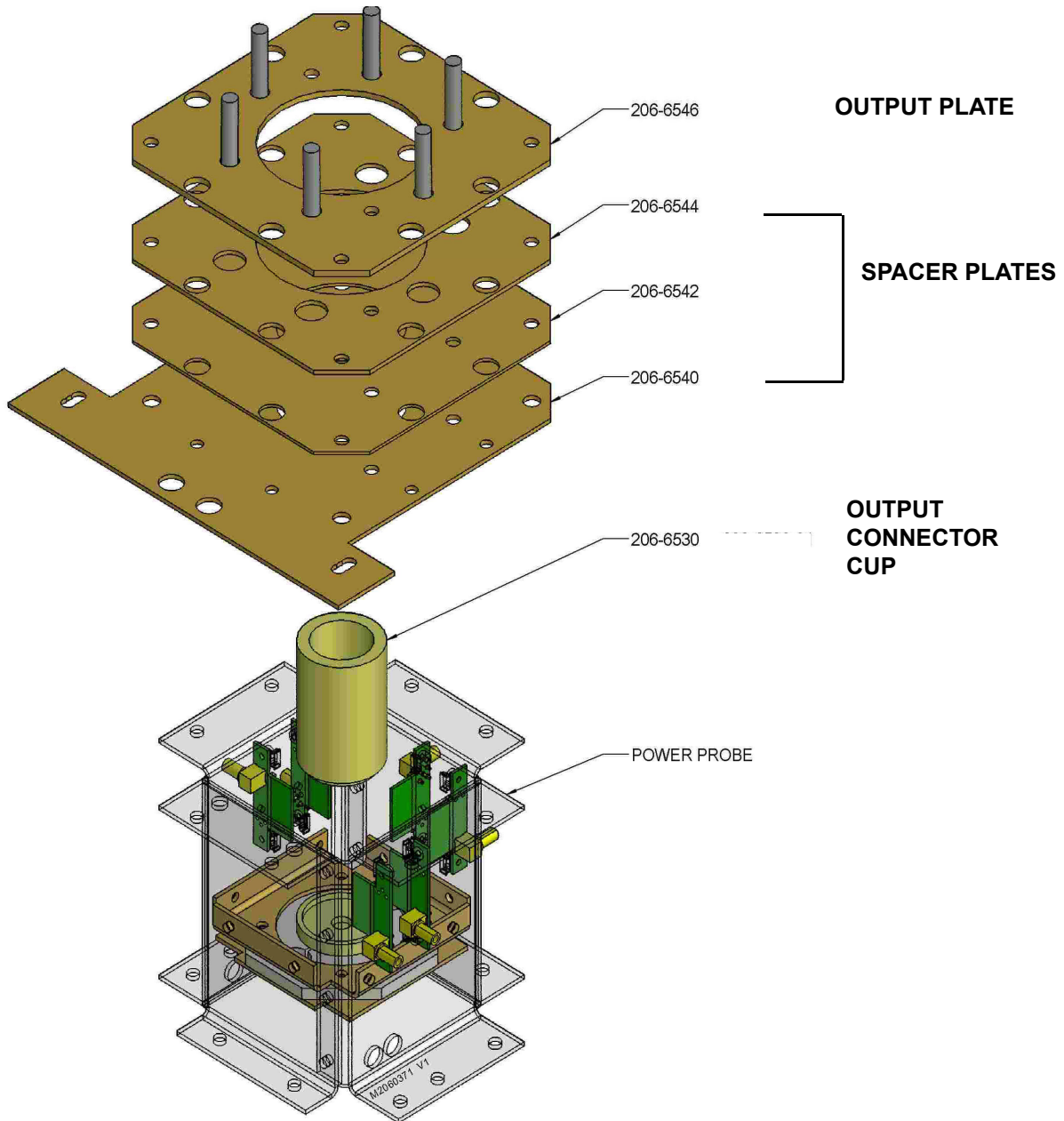

Figure 2.2.5: RF Output Connector Assembly Detail - 7/8 inch EIA (optional)



TORQUE OUTPUT CONNECTION TO 60 IN-LBS

Figure 2.2.6: RF Output Connector Assembly Detail - 3-1/8 inch EIA (Optional)



TORQUE OUTPUT CONNECTION TO 60 IN-LBS

## SECTION 2.3: INSTALLING OPTIONS

The NV5LT/NV3.5LT transmitter is factory configured and shipped to operate with the customer’s desired ac power source voltage and RF output connector size. There are options available for various other features, including dual exciter, UPS interface, redundant LVPS, and remote interfacing. These options may be installed in one of two ways:

- ❖ You install and configure options at your site, using kits and instructions provided by Nautel. Each option has a separate kit.
- ❖ Pre-arrange for Nautel to install and configure options at the factory prior to shipping.

Table 2.3.1 shows the standard (default) configuration of the NV5LT/NV3.5LT, as well as available options. Each option references a schedule of installation and how to install the option. Review the options to determine which, if any, apply to your installation.

If you did not purchase any options for your NV5LT/NV3.5LT and intend to operate with the standard (default) configuration, proceed to Section 2.4, “Connecting to Station Reference Ground”.

**NOTE:** When an option is installed (UPS interface, dual exciter, etc.), the extra parts removed (e.g., blank exciter panel, AC LED cover) from the original configuration are placed in the Ancillary kit.

Table 2.3.1: NV5LT/NV3.5LT Available Options

ITEM/ FEATURE	STANDARD CONFIGURATION	AVAILABLE OPTIONS	WHEN TO INSTALL?	HOW TO INSTALL?
Exciter	Single Exciter, integrated into controller (NAE106*)	Exciter B (NAE107*)	Station convenience	See “Upgrading to Dual Exciter” on page 2.3.2
UPS Interface	No UPS interface	UPS Interface Assembly and ac input connectors (219-5140-02); user provides UPS and wiring	Station convenience	See “Installing the UPS Interface” on page 2.3.3
LVPS	Single LVPS A (UG132)	LVPS B (UG132)	Station convenience	See “Redundant LVPS Upgrade” on page 2.3.4
Remote Control/Monitor	Connectors on controller (NAE106*) rear panel	Remote Interface PWB Kit (NAPI143/01)	Station convenience	See “Installing the Remote Interface PWB” on page 2.3.5
Internal Audio Processor	No internal audio processor	Orban Inside Kit(s) (for one or both exciters, as desired)	Station convenience	See “Installing the Orban Inside Card” on page 2.3.6

## Upgrading to Dual Exciter

The NV5LT/NV3.5LT is factory configured with a single exciter - part of the controller (A4). You can upgrade your transmitter with a second exciter (exciter B), which provides additional redundancy.

1. Turn off (disable or lock out, as applicable) the main ac power for the transmitter.
2. Obtain "QG12004\* - NVLT Dual Exciter Upgrade Quick Guide" (see Figure 2.3.1) that was provided with the Dual Exciter Upgrade Kit and complete its outlined procedure.

Figure 2.3.1: Dual Exciter Upgrade Quick Guide (QG12004\*)

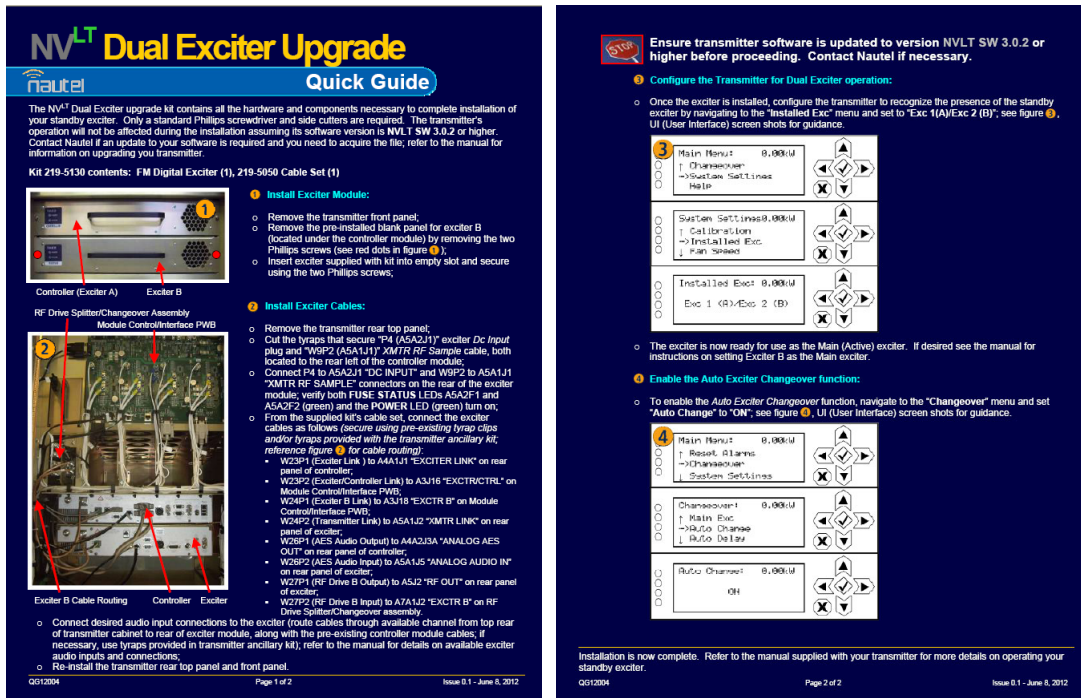

SHOWN FOR REFERENCE ONLY

3. If you are performing this upgrade in conjunction with the NV5LT/NV3.5LT's initial installation, leave the front and rear panels off to allow further installation. If you are performing this upgrade after initial installation has already been completed, re-install the front and rear panels.



# Installing the UPS Interface

The NV5LT/NV3.5LT is factory configured with no UPS interfacing ability. You can install a UPS interface assembly, which allows you to interface with a user-provided UPS that can act as a backup power source for the transmitter’s low voltage power supplies in the event of an ac power failure.

**WARNING! ENSURE THAT AC POWER IS NOT BEING APPLIED TO THE TRANSMITTER DURING THIS PROCEDURE.**

1. Obtain the “QG12007\* - NVLT UPS Interface Upgrade Quick Guide” (see Figure 2.3.2) that was provided with the UPS Interface Upgrade Kit.
2. Complete the procedure outlined in the “NVLT UPS Interface Upgrade Quick Guide”.

Figure 2.3.2: UPS Interface Upgrade Quick Guide (QG12007\*)

> Connect the UPS interface assembly to the LVPS distribution plate as follows:

- o (See Figures 3 and 4 for reference) Temporarily remove the M4 screw that secures the pre-existing wire at terminals E10 and E11, install the following wire's lug, along with the pre-existing wire lug, using the same M4 screw to secure both lugs in place.
  - Connect the white, 10 AWG wire (+V) to E10 on the LVPS distribution plate.
  - Connect the black, 10 AWG wire (-V) to E11 on the transmitter wall next to the LVPS distribution plate.

> Wire external UPS ac to the UPS interface assembly; consider the following:

- o A pre-existing 1/2-inch pilot hole exists at the top of the transmitter cabinet (to the right-hand side of the ac entrance hole as viewed from the rear of the NV15LT to NV40LT, and to the left-hand side of the ac entrance hole as viewed from the rear for NV3.5LT to NV10LT) to allow an increase in hole size (using a Greenlee punch) to facilitate entrance of input wiring for the external UPS.
- o The kit is supplied with one (1) adequately rated IEC 320 plug for customer use; however, the customer must supply external wiring (minimum 5A rating; consider UPS short circuit rating).
- o From within the transmitter cabinet, route UPS wiring from the top access hole down the inside left-hand side of the cabinet to the J1 connector of the UPS interface assembly.
- o Re-install the power supply exhaust grill plate and rear top and bottom panels.

> Configure the transmitter to recognize an external UPS:

- o Apply ac power to the UPS interface assembly (power up the UPS). Verify the controller module turns on.
- o Unlock and turn on the transmitter's main ac power supply. Verify the AC OK and DC OK LEDs on the LVPS module(s) are solid green.
- o Allow the protection/monitoring function to recognize the use of an external UPS by navigating the User Interface's menu: Select System Settings > UPS Installed from the User Interface menu (newer software versions have a HW Config sub-menu in System Settings). Set to "YES".

NOTE: Wiring and connection details to the external UPS are beyond the scope of this document.

Installation of the UPS interface assembly is complete.

Figure 1: Removal of power supply exhaust grill plate.

Figure 2: Removal of Ac Present LED cover

Figure 3: UPS Interface Assembly installed

Figure 4: Wiring to the LVPS Distribution Plate (NV3.5LT to NV10LT)

Figure 5: Wiring to the LVPS Distribution Plate (NV15LT to NV40LT)

SHOWN FOR REFERENCE ONLY

3. Do not re-install the rear panels at this time.

# Redundant LVPS Upgrade

The NV5LT/NV3.5LT is factory configured with a single LVPS module. You can upgrade your transmitter with a second LVPS module (LVPS B), which provides redundancy as well as a spare power supply for the RF power modules.

1. Obtain "QG12005\* - NVLT Redundant LVPS Quick Guide" (see Figure 2.3.3) that was provided with the Dual LVPS Upgrade Kit and complete its outline procedure.

Figure 2.3.3: Redundant LVPS Quick Guide (QG12005\*)

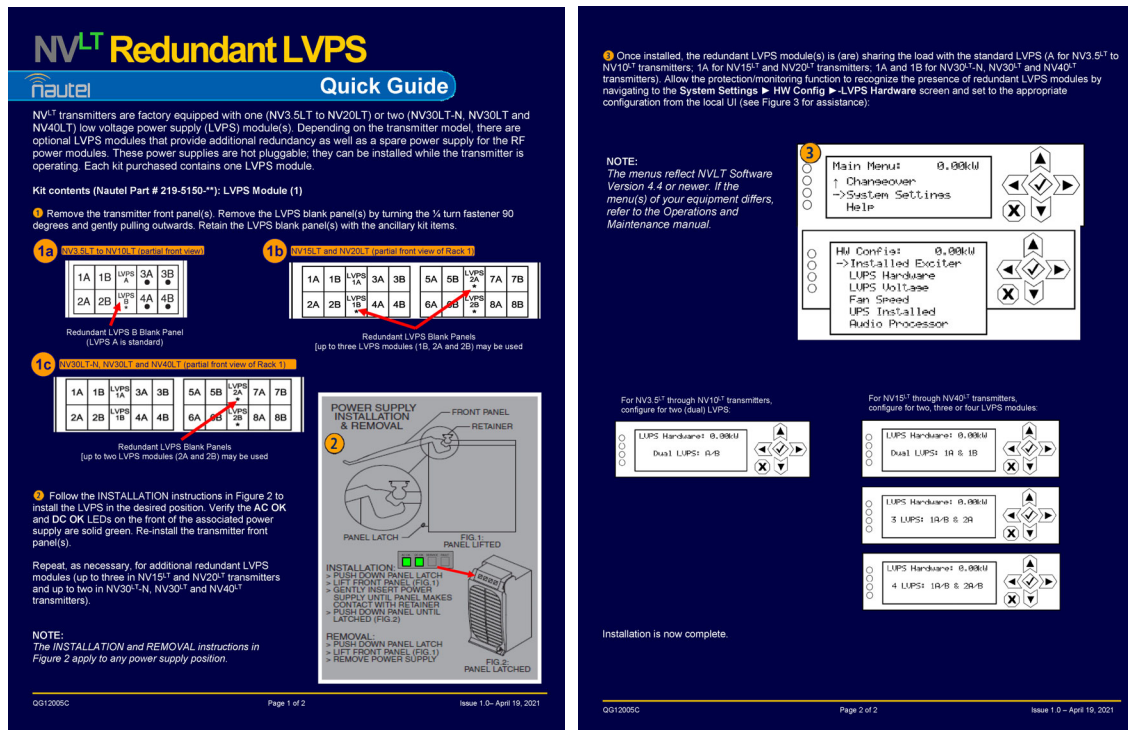

SHOWN FOR REFERENCE ONLY

2. If you are performing this upgrade in conjunction with the NV5LT/NV3.5LT's initial installation, leave the front panel off to allow further installation. If you are performing this upgrade after initial installation has already been completed, re-install the front panel.



## Installing the Remote Interface PWB

The NV5LT/NV3.5LT is factory configured with a controller (A4), which provides remote control and monitoring interfacing on its rear panel. You can install a remote interface PWB (Nautel Part # NAPI143/01) behind the hinged, front UI panel, which provides a more convenient location to make remote wiring connections. The remote interface PWB also contains control switches (push-buttons) and monitoring LEDs, which provide backup control and monitoring for the transmitter in the event of a failure with the front panel UI or remote AUI. It also provides analog output samples of key parameters (forward power, reflected power, PA voltage and total current) for monitoring.

**WARNING! ENSURE THAT AC POWER IS NOT BEING APPLIED TO THE TRANSMITTER DURING THIS PROCEDURE.**

1. Obtain "QG12006\* - NVLT Remote Interface PWB Upgrade Quick Guide" (see Figure 2.3.4) that was provided with the Remote Interface PWB Upgrade Kit and complete its outlined procedure.

Figure 2.3.4: Remote Interface PWB Quick Guide (QG12006\*)

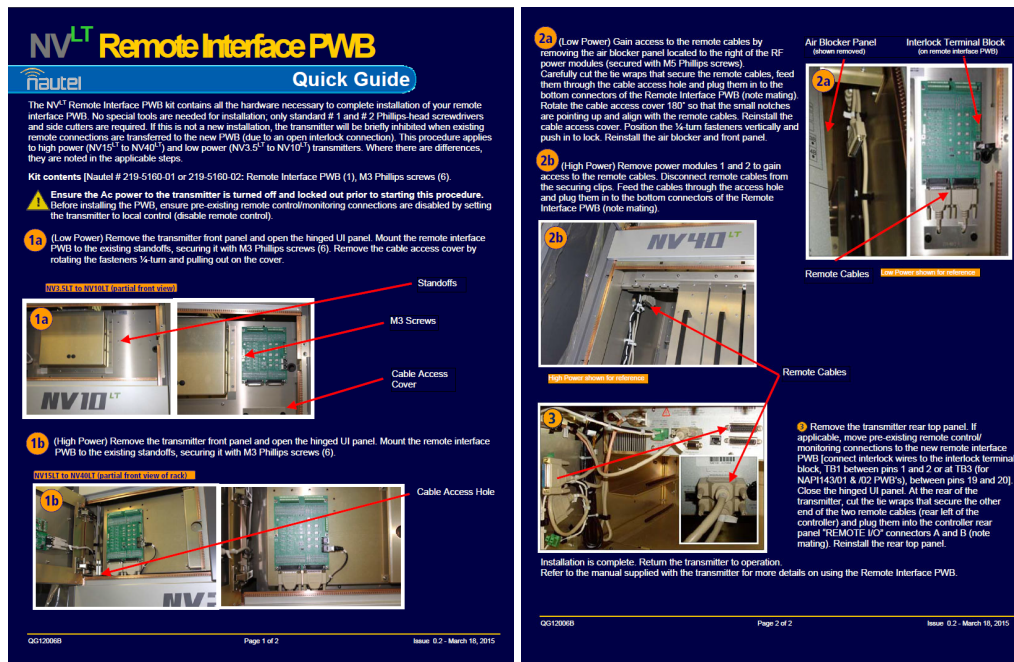

2. If you are performing this upgrade in conjunction with the NV5LT/NV3.5LT's initial installation, leave the front panel off to allow further installation. If you are performing this upgrade after initial installation has already been completed, re-install the front panel.

**NOTE:** Installing this option changes the location of remote control/monitor and interlock connections. See Section 2.8, "Installing Control/Monitor Wiring" on page 2.8.1 for more information.

## Installing the Orban Inside Card

The NV5LT/NV3.5LT is factory configured with no internal audio processor. You can install an Orban Inside audio processor card in one or both exciters, as applicable. The controller and optional exciter, if applicable, must be removed from the transmitter to install the Orban Inside card. Once the Orban Inside card is installed, you can configure its audio processor settings using the remote AUI (see the NV5LT/NV3.5LT Operation & Maintenance Manual for more details).

**WARNING! ENSURE THAT AC POWER IS NOT BEING APPLIED TO THE TRANSMITTER DURING THIS PROCEDURE.**

1. Obtain the "QG12001\* - Orban Inside Upgrade Quick Guide" (see [Figure 2.3.5](#)) that was provided with the Orban Inside Kit and complete its outlined procedure for each desired exciter. The controller's integral exciter is exciter A and the optional exciter is exciter B.

Figure 2.3.5: Orban Inside Upgrade Quick Guide (QG12001\*)

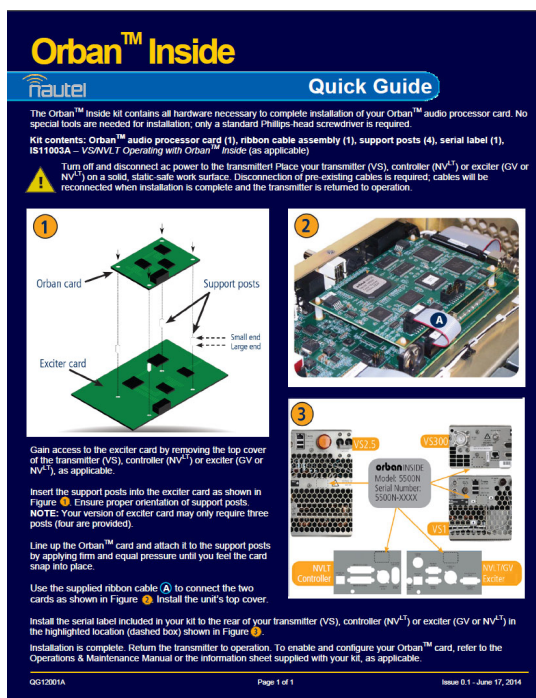

SHOWN FOR REFERENCE ONLY

2. If you are performing this upgrade in conjunction with the NV5LT/NV3.5LT's initial installation, leave the front and rear panels off to allow further installation. If you are performing this upgrade after initial installation has already been completed, re-install the front and rear panels.

---

## SECTION 2.4: CONNECTING TO STATION REFERENCE GROUND

To connect to the station reference ground, perform the following steps:

1. Locate the safety ground stud assembly (E1) for the transmitter at the bottom rear of the cabinet (see [Figure 2.4.1 on page 2.4.2](#)).
2. Attach a continuous, low impedance conductor (minimum four-inch copper strap) between the station reference ground and the stud assembly (E1) on the cabinet. Secure the conductor to E1 using the stud's 3/8-inch nut and a suitable wrench. Ensure the reference ground conductor is at least 3 mm (1/8 in) from the cabinet's exterior.

**CAUTION!** IT IS IMPORTANT THAT THE CONDUCTOR ATTACHED TO E1 DOES NOT CONTACT THE TRANSMITTER CHASSIS AT ANY OTHER POINT.

3. For information about grounding the lightning protection, see the NV5LT/NV3.5LT Pre-Installation Manual. For detailed information about lightning protection, see the Nautel Site Preparation Manual, available from your Nautel sales agent, or online from the Nautel website.
4. Firmly tighten all hardware. Do not re-install the rear panels at this time.

Figure 2.4.1: Station Reference Ground Strap Connection

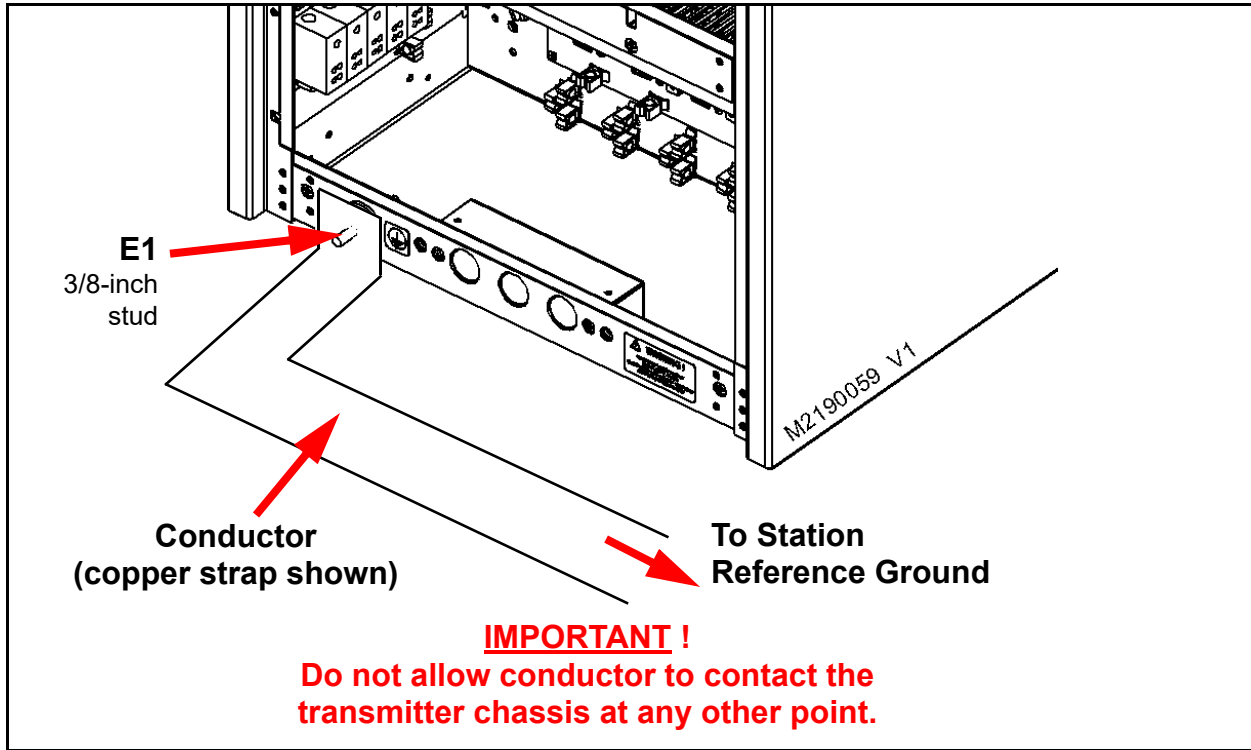

---

## SECTION 2.5: CONNECTING AC POWER

Connect ac power to the transmitter as follows:

**NOTE:** The transmitter's internal wiring is factory configured to operate from the customer's desired ac power source. Ensure that the ac configuration label on the transmitter agrees with the main ac power source voltage that you are connecting.

1. Switch off the main ac power at the service entrance. As viewed from the rear, rRemove the left-hand side rear filter panel (1/4-turn fasteners) and bottom ac panel (M5 screws) from the transmitter to allow access to the ac input routing channel, the ac input terminal block and UPS interface, as applicable.
2. To improve access, temporarily remove the grilled panel just above the ac section (four M4 screws, see [Figure 2.5.1 on page 2.5.5](#)).

**WARNING! ENSURE THAT WIRING SIZES ARE APPROPRIATE. AC WIRING MUST BE INSTALLED BY A QUALIFIED, LOCALLY-CERTIFIED ELECTRICIAN.**

3. Select the appropriate wire size for your main ac power cables. See the NV5LT/NV3.5LT Pre-Installation Manual for assistance. Ensure the ground wire is insulated, so it does not contact the transmitter cabinet at any location other than the safety ground stud.

**NOTE:** Some types of cable (e.g., TEC cable) have an exposed ground wire. In such cases, Nautel recommends that you sleeve (insulate) the ground wire.

4. Route the main ac power cables in a suitable conduit, from the ac disconnect switch to the top of the transmitter or bottom of the transmitter, depending on your desired entry point.
5. Punch the appropriate size hole in the ac entry box as follows (see [Figure 2.5.1 on page 2.5.5](#)):
  - ❖ Remove the top cover from the ac entry box. It is secured using four M4 screws and has three pre-cut, 1/4-inch diameter holes.
  - ❖ Use a chassis punch tool (e.g., Greenlee, etc.) to punch the desired size hole(s) in the top cover. Make sure the ac input cables will pass safely through the hole(s).
  - ❖ Re-install the top cover on the ac entry box using four M4 screws.

6. Prepare the desired ac input entry hole as follows:
  - ❖ For top entry, punch the appropriate size hole in the ac entry plate as follows (see [Figure 2.5.1 on page 2.5.5](#)):
    - Remove the ac entry plate from the top of the transmitter. It is secured using four M4 screws and has a pre-cut, centered 1/4-inch diameter holes.
    - Use a chassis punch tool (e.g., Greenlee, etc.) to punch the desired size hole(s) in the ac entry plate. Make sure the ac input cables will pass safely through the hole. If necessary, you can remove the plate completely to gain access to a 2.5-inch diameter hole.
    - Re-install the ac entry plate on top of the transmitter using four M4 screws.
  - ❖ For bottom entry, remove the hole plug from the bottom ac input entry hole (2-inch diameter, see [Figure 2.5.1 on page 2.5.5](#)) or carefully drill the appropriate size hole in the hole plug.

**NOTE:** Cutting an 'X' shaped slit in the hole plug eases plug removal.

7. Verify that the station reference ground is connected to the ground stud at the back of the cabinet. See [Section 2.4, "Connecting to Station Reference Ground" on page 2.4.1](#), if necessary.
8. Route the main ac power cables through the top or bottom ac entry hole.

**NOTE:** The NV5LT/NV3.5LT contains pre-installed ferrite toroids for internal ac wiring. For this reason, additional ferrite toroids should not be required for the ac input wiring. The ancillary kit contains ferrite toroids (Nautel Part # LP32) for use with the ac input wiring, if desired.

9. Route the ac power cables through the hole(s) punched in the top of the ac input entry box to the ac input terminal block (TB1) (see [Figure 2.5.1 on page 2.5.5](#)).

**NOTE:** The NV5LT/NV3.5LT contains pre-installed ferrite toroids for internal ac wiring. For this reason, additional ferrite toroids should not be required for the ac input wiring. The ancillary kit contains ferrite toroids (Nautel Part # LP32) for use with the ac input wiring, if desired.

10. Route the ac power cables to the vicinity of the ac input terminal block (TB1):
  - ❖ For top entry, Nautel recommends you route cables through the built-in conduit (channel) on the left-hand side of the cabinet (see channel entry and exit points on [Figure 2.5.1 on page 2.5.5](#); conduit dimensions are 2-1/16 inches x 3/4 inches). Ensure there is wear strip at the channel entry and exit points to protect the cable insulation from wearing. If your ac wiring will not pass through the channel, route it along the outside of the channel using the provided tyrap anchor holes and secure the cables using Nautel Part # HAC15 snap-mount tyrap (for 0.25" holes), provided in the ancillary kit. The channel exit point is just above TB1.
  - ❖ For bottom entry, route the cables from the bottom entry hole to the input side of TB1.

11. Temporarily remove the rear cover from the ac input entry box (four M4 screws), noting the cover is secured to the box with a bonding (ground) wire, which should not be disconnected.
12. With the main ac power cables near terminal block TB1, cut each wire to the required length and remove 1.9 cm (3/4 in.) of insulation from the end of each conductor.
13. Connect the main ac power source as follows:

**NOTE:** The following tools are required for installation (user provided): 3/16-inch, 1/4-inch hex Allen keys and a suitable torque wrench to tighten ac input wiring.

- ❖ For THREE-PHASE AC POWER SOURCES, connect the three ac line inputs to terminals 1A (L<sub>1</sub>), 2A (L<sub>2</sub>) and 3A (L<sub>3</sub>) of terminal block TB1. Connect the ac neutral (as required, such as with ac power source voltages between 303 and 459 V ac) to terminal 4A (N). Connect the ac ground to terminal 5A. Secure all wires in their respective terminals.
- ❖ For SINGLE-PHASE AC POWER SOURCES (European/Asian standards), connect the ac line and neutral inputs to terminals 1A (L<sub>1</sub>) and 2A (L<sub>2</sub>/N) respectively. Connect the ac ground to terminal 5A. Secure all wires in their respective terminals.
- ❖ For SINGLE-PHASE AC POWER SOURCES (North American standards), connect the two 110 V ac lines (neutral not required) to terminals 1A (L<sub>1</sub>) and 2A (L<sub>2</sub>/N). Connect the ac ground to terminal 5A. Secure all wires in their respective terminals.
- ❖ Torque securing hardware on TB1-1 through TB1-4 to 13.631.1 N-m (120275in-lbs) using a user-supplied torque wrench with a 3/16 1/4 inch hex bit. Torque securing hardware on TB1-5 (ground) to 13.6 N-m (120 in-lbs) using a user-supplied torque wrench with a 3/16 inch hex bit.
- ❖ Re-install the rear cover on the ac entry box (four M4 screws), ensuring the bonding (ground wire) is not pinched.

14. If the UPS interface option has been installed, remove the bottom UPS Entry panel (eleven M5 screws) and route the ac cable from the user-provided UPS, through the desired top or bottom entry point (see [Figure 2.5.1 on page 2.5.5](#)), to the UPS interface assembly at the bottom of the transmitter. Install the Nautel provided mating connector and install the ac cable on the UPS interface assembly. Refer to "[Configuring an External UPS](#)" on [page 2.9.7](#)" [Configuring an External UPS](#)" on [page 2.9.11](#) to configure the transmitter to recognize the UPS. See the NV5LT/NV3.5LT Pre-installation Manual for more information.
15. Re-install the gridded panel that was removed in [Step 2](#), using four M4 screws.
16. If previously removed, rRe-install the bottom rear panel removed in [Step 1](#)[Step 14](#), using the retained M5 screws.
17. Do not install the rear filter panel at this time.



Figure 2.5.1: Ac Mains and UPS Input Routing and Connections

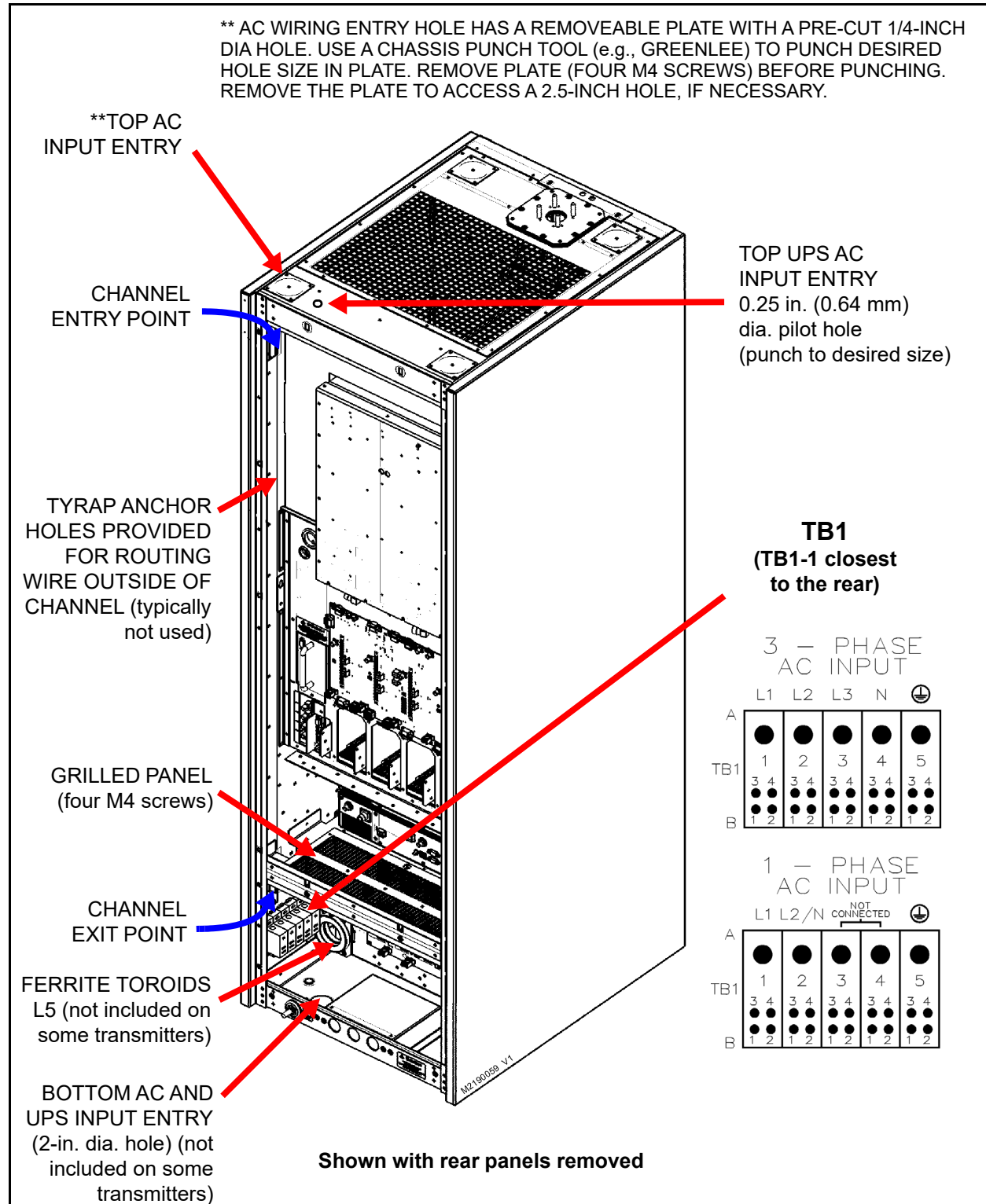



---

## SECTION 2.6: INSTALLING THE RF FEED CABLE

Prepare and install an RF feed coaxial cable as follows:

**WARNING! ENSURE THAT AC POWER IS NOT BEING APPLIED TO THE TRANSMITTER DURING THIS PROCEDURE.**

**NOTE:** Nautel recommends that you perform the commissioning procedure in [Section 2.9, "Commissioning"](#), which connects the transmitter to a dummy load, before connecting the transmitter to its antenna system.

1. Make sure the transmitter is configured for the correct RF output connector. It is factory configured for the customer's desired RF output connector [1-5/8 inch EIA (standard), 3-1/8 inch EIA (optional) or 7/8 inch EIA (optional)].
2. Connect the transmitter's RF output to a dummy load, if available, during the commissioning procedure's initial turn on.
3. Verify the RF feed cable is in place and is cut to the required length. Do not install the EIA flange connector at this point.
4. Get two ferrite toroids from the ancillary kit that are sufficient to accommodate the associated feed cable or hardline. For 1-5/8 inch or 7/8 inch feed cable, use Nautel Part # LP23 (2.187 inch inner diameter). For 3-1/8 inch feed cable, use Nautel Part # LP32 (4.165 inch inner diameter). Install two ferrite toroids on the transmitter end of the feed cable or hardline. See [Figure 2.6.1 on page 2.6.2](#).
5. Install the user-provided appropriate size EIA flange connector on the feed cable.
6. If the RF feed cable's EIA flange connector does not have a male connector for the center conductor, obtain an EIA bullet for the EIA flange connector. Nautel does not provide an EIA bullet.

**NOTE!** Nautel does not typically supply bullets as there is no guarantee that they will be compatible with all potential hardline used at the customer's site. It is recommended that the customer supply this part and ensure a snug fit exists between the transmitter RF output cup and EIA flange connector in [Step 6](#) and [Step 8](#). Use sufficient insertion force to ensure low contact resistance. Failure to observe these recommendations may result in damage to the transmitter or feedline.

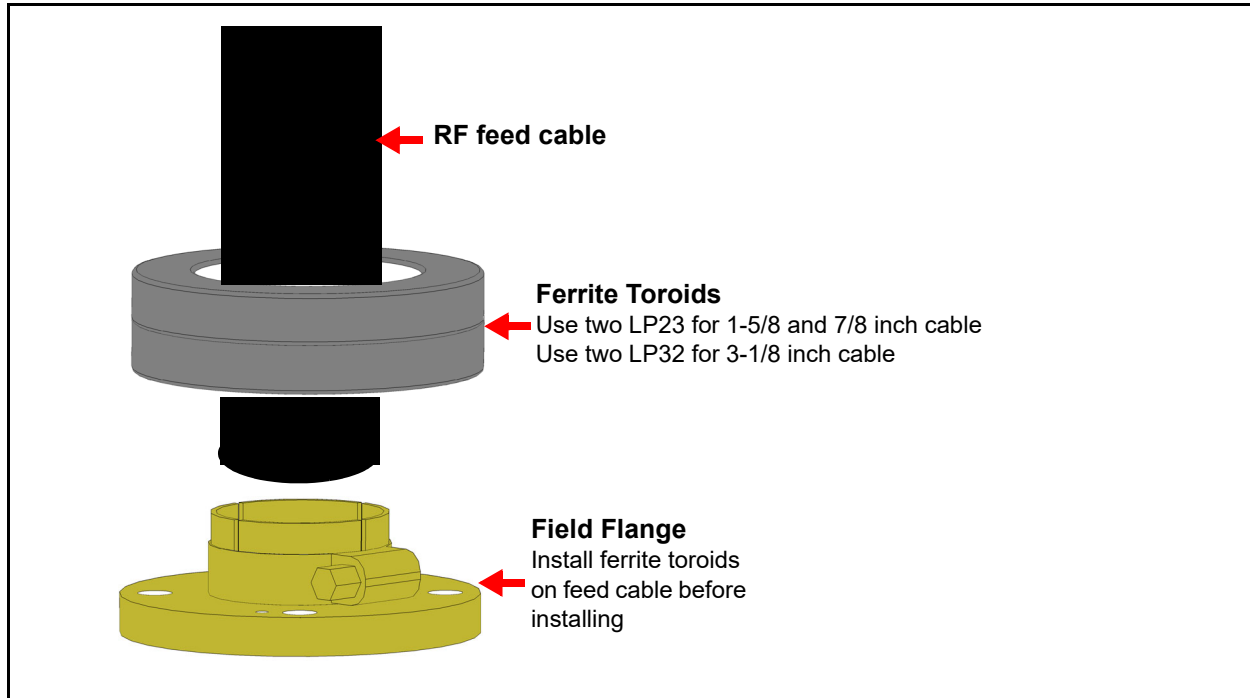
*Figure 2.6.1: Passing RF feed cable through ferrite toroids*

7. Locate and remove the hardware (nuts, split washers and flat washers) from the output stud plate on the top of the transmitter RF output connector. The size of the hardware depends on the size of the RF output connector (5/16 hardware for 1-5/8 and 7/8 output; 3/8 inch hardware for 3-1/8 output).
8. Carefully install the RF feed cable's EIA flange connector on the RF connector's flange-mounting studs. Ensure its bullet mates with the rigidly mounted cup connector inside the RF output connector and the alignment pin of the flange lines up with the clearance hole in the stud plate. Ensuring the bullet has a tight fit to minimize overheating. Secure using attaching hardware removed in [Step 7](#). Ensure nuts are firmly tightened.

---

## SECTION 2.7: INSTALLING PROGRAM INPUTS

This section describes how to route program input wiring to the NV5LT/NV3.5LT's exciter(s).

### Planning Complete?

1. Make sure you have read and fully understood the program input options described in the NV5LT/NV3.5LT Pre-installation Manual before proceeding.
2. Make sure the program input wires are long enough to allow routing through the top of the transmitter cabinet and down to the rear panel of the controller and exciter (if applicable).
3. If you ordered the optional Exciter Upgrade kit, make sure it is installed (see [“Upgrading to Dual Exciter” on page 2.3.5](#)). The transmitter is factory configured with a single exciter - within the controller (A4).
4. If you ordered the optional Orban Inside Audio Processor kit for one or both exciters, as applicable, make sure it is installed (see [“Installing the Orban Inside Card” on page 2.3.8](#)). The transmitter's exciters are factory configured with no Orban Inside audio processor card.

### Routing Cables

Route the desired analog and digital program input cables to the back of the NV5LT/NV3.5LT's controller and optional exciter.

1. Route all program input cables from their audio sources to the top of the transmitter. If you are using dual exciters, you will need two sets of program inputs - one for each exciter.
2. Get two ferrite toroids (Nautel Part # LXP38, 19 mm inner diameter) from the ancillary kit for each exciter installed. The controller's integral exciter is exciter A. The optional exciter, if installed, is exciter B.
3. Pass all program input cables through the ferrite toroids obtained in [Step 2](#). If practical, wires should pass through a minimum of two times (two turns) (see [Figure 2.7.1 on page 2.7.2](#)). An entrance is provided at the top of the transmitter to accept program input wiring. Position the ferrite toroids just outside, or just inside, the program input entry hole.
4. Punch the appropriate size hole in the program input entry plate (see [Figure 2.7.2 on page 2.7.3](#)):
  - ❖ Remove the program input entry plate from the top of the transmitter. It is secured using four M4 screws and has a pre-cut, centered 1/4-inch diameter hole.

Figure 2.7.1: Passing program input wiring through ferrite toroids

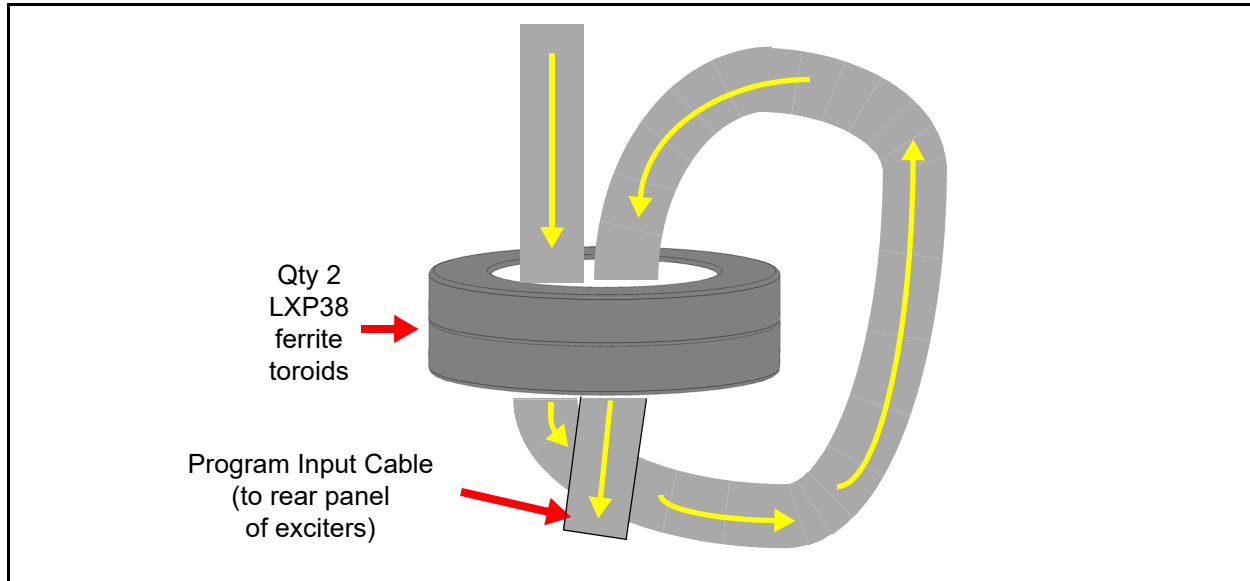

- ❖ Use a chassis punch tool (e.g., Greenlee, etc.) to punch the desired size hole in the program input entry plate. Make sure the program input cables will pass safely through the hole. If necessary, you can remove the plate completely to gain access to a 2.5-inch diameter hole.
  - ❖ Re-install the program input entry plate on top of the transmitter using four M4 screws.
5. Route the program input cables through the entry hole. Once the cables are inside the transmitter, Nautel recommends you route cables to the controller and optional exciter B through the built-in conduit (channel) on the right-hand side of the cabinet (as viewed from the rear; see channel entry and exit points on [Figure 2.7.2 on page 2.7.3](#); conduit dimensions are 1-11/16 inches x 3/4 inches). If possible, install exciter mating connectors after passing cables through the conduit. Wear strip is factory installed at the channel entry and exit points to protect the cable insulation. If your program wiring will not pass through the channel, route it along the outside of the channel using the provided tyrap anchor holes and secure the cables using Nautel Part # HAC15 snap-mount tyraps (for 0.25" holes), provided in the ancillary kit.

**NOTE:** When routing program cables through the built-in conduit, consider the possibility that remote control/monitor wires and a LAN cable may also pass through the conduit (see [Section 2.8, "Installing Control/Monitor Wiring" on page 2.8.1](#)).

6. With the program input cables near the rear of the controller and optional exciter, cut each wire to the required length, and install connectors, as necessary.
7. Remove plastic cap-plugs from the connectors on the controller and exciter, if applicable.
8. Connect the appropriate program input cable(s) to the controller and optional exciter connector(s) described in Section 1.7 of the NV5LT/NV3.5LT Pre-installation Manual.

Figure 2.7.2: Routing Program Input Cables

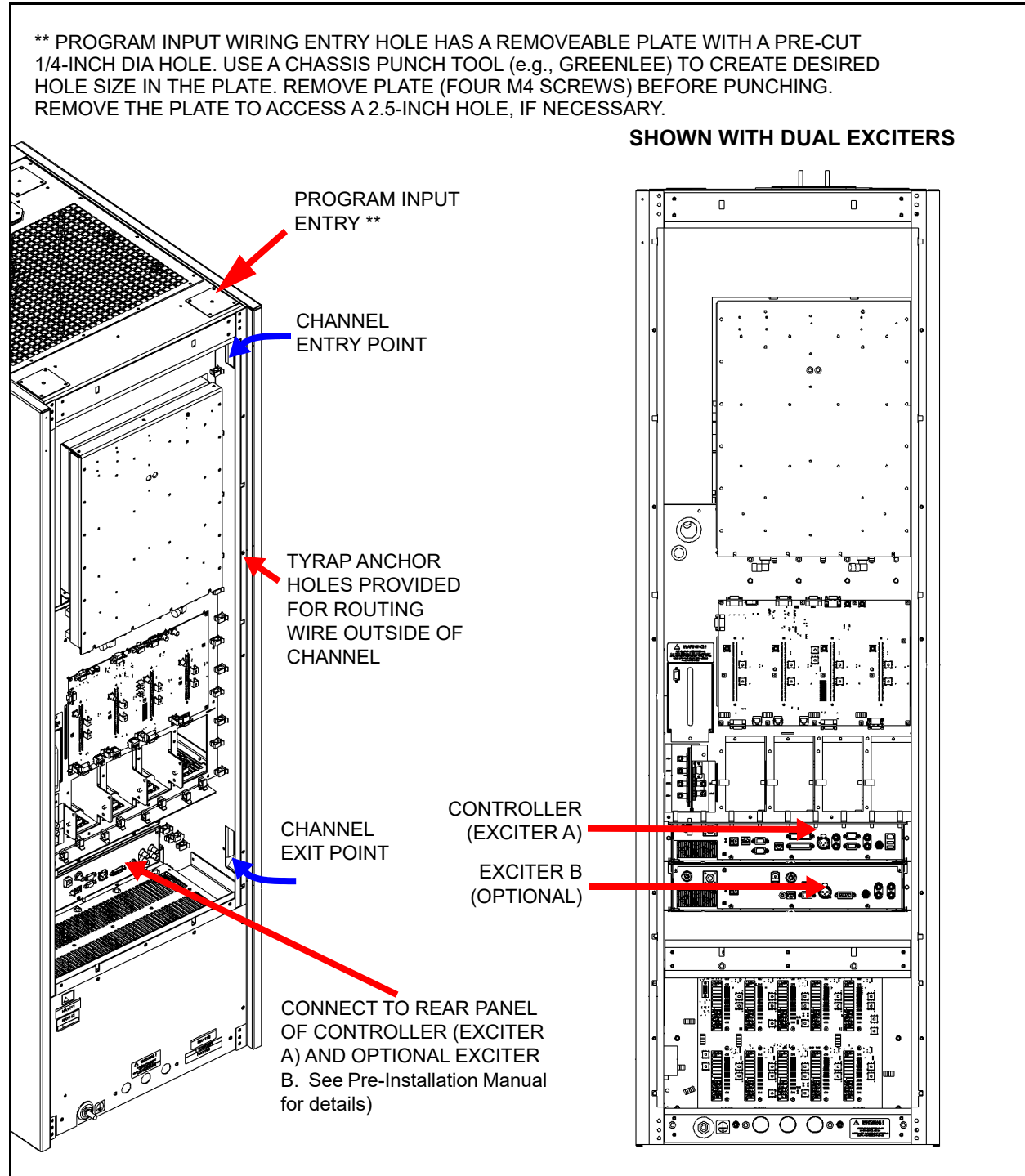





---

## SECTION 2.8: INSTALLING CONTROL/MONITOR WIRING

This section describes how to route wiring associated with the remote control and monitoring of the NV5LT/NV3.5LT transmitter.

### Planning Complete?

1. Make sure you have read and fully understood the control and monitoring options described in the NV5LT/NV3.5LT Pre-installation Manual before proceeding.
2. Make sure the control/monitor wires are long enough to allow routing through the top of the transmitter cabinet and down to the rear panel of the controller (A4) or optional remote interface PWB (A16) at the top, front of the transmitter.
3. If you ordered the optional Remote Interface PWB Kit, make sure it is installed (see [“Installing the Remote Interface PWB”](#) on page 2.3.5). The transmitter is factory configured without the remote interface PWB.

**NOTE:** The transmitter’s factory configuration allows for remote interfacing with connectors on the rear of the controller (A4). If you installed the optional remote interface PWB (A16) (see [Figure 2.8.2](#) on page 2.8.4), you can interface with connectors on the remote interface PWB, which is located behind the front, hinged UI panel.

### Routing Cables

1. Route all remote control/monitor cables to the top of the transmitter.
2. Get two ferrite toroids (Nautel Part # LXP38, 19 mm inner diameter) from the ancillary kit.
3. Pass all remote control and monitor cables through the ferrite toroids obtained in [Step 2](#). If practical, wires should pass through a minimum of two times (two turns) (see [Figure 2.8.1](#)).
  - ❖ If remote control/monitor wiring is being routed to the rear of the controller (A4), use the entrance hole at the top, rear of the transmitter (same hole as program input cable entry).
  - ❖ If remote control/monitor wiring is being routed to the optional remote interface PWB (A16), use the entrance hole at the top, front, right-hand side of the transmitter.
  - ❖ Position the ferrite toroids near the transmitter cabinet - on top or inside.

Figure 2.8.1: Passing remote/control monitor wiring through ferrite toroids

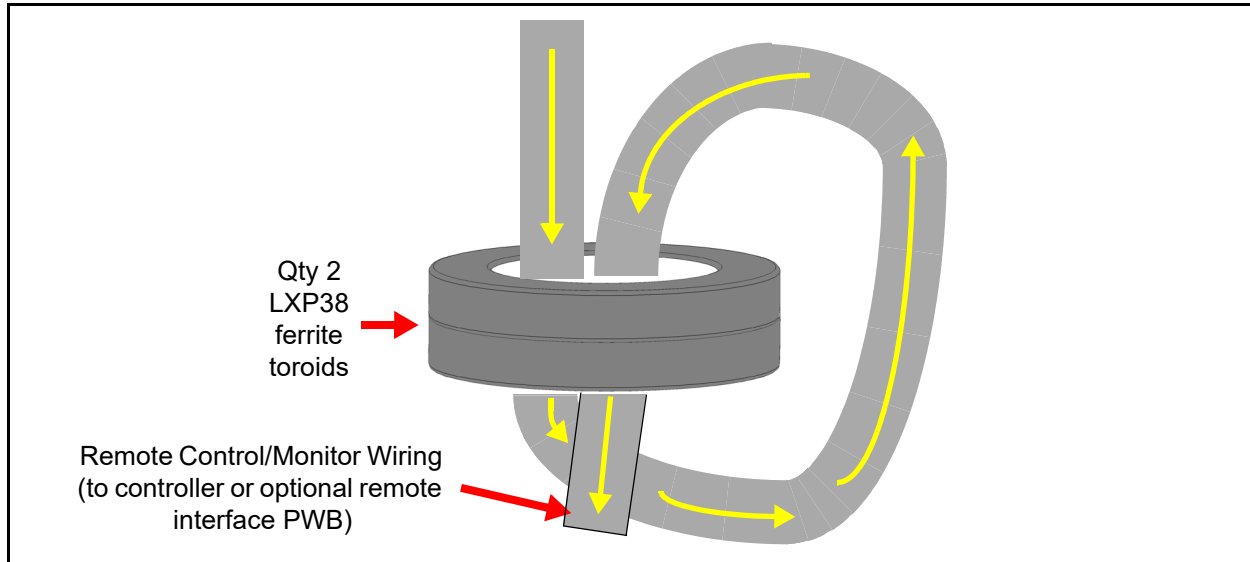

4. Punch the appropriate size hole in the desired remote control/monitor entry plate as follows (see [Figure 2.8.2](#) on [page 2.8.4](#)):
  - ❖ Remove the desired remote control/monitor entry plate from the top of the transmitter, noting there are two in the front and one in the rear. The rear plate is also used for program input cables. Each plate is secured using four M4 screws and has a pre-cut, centered 1/4-inch diameter hole.
  - ❖ Use a chassis punch tool (e.g., Greenlee, etc.) to punch the desired size hole in the selected remote control/monitor entry plate. Make sure the cables will pass safely through the hole. If necessary, you can remove the plate completely to gain access to a 2.5-inch diameter hole.
  - ❖ Re-install the remote control/monitor entry plate on top of the transmitter using four M4 screws.
5. With the rear filter panel removed or the front, hinged panel open, as applicable, route the remote control/monitor cables through the selected entry hole and then to the controller's (A4) rear panel or to the optional remote interface PWB (A16) (see [Figure 2.8.2](#) on [page 2.8.4](#)).

**NOTE:** When routing remote control/monitor and LAN cables through the built-in conduit, consider the possibility that program cables may also pass through the conduit (see [Section 2.7, "Installing Program Inputs"](#) on [page 2.7.1](#)).

6. With the remote control/monitor cables near their destination - either at the top of the remote interface PWB or at the rear of the controller, cut each wire to the required length, and install connectors, as necessary.

- 
7. Connect the appropriate control/monitor cable(s) to the connector(s) described in Section 1.8 of the NV5LT/NV3.5LT Pre-installation Manual.
    - ❖ If your transmitter has the optional remote interface PWB, route the control/monitor cables to the top edge of the remote interface PWB. Strip a small amount of wire from the end of each wire and connect the control/monitor cables to the appropriate terminals of the CUSTOMER ALARM/STATUS (TB2) and CUSTOMER CONTROL (TB3) terminal blocks.
    - ❖ If your transmitter has the standard configuration (i.e., no remote interface PWB), route the control/monitor cables to the rear of the controller (A4). The transmitter's ancillary kit contains male (Nautel Part # JS31) and female (Nautel Part # JS28) 25-pin D-sub connectors and connector shells (Nautel Part # JS35) to facilitate connections to the REMOTE I/O-A (A1J2A) and REMOTE I/O-B (A1J2B) 25-pin D-sub connectors.
  8. For the transmitter's external interlock control, route a shielded cable to one of the following locations:
    - ❖ If your transmitter has the optional remote interface PWB, connect the shielded cable to TB1, between INTLK terminals 1 and 2 (see [Figure 2.8.2 on page 2.8.4](#)) or between terminals 19 and 20 on the CUSTOMER CONTROL terminal block (TB3). Use one option only; do not use both.
    - ❖ If your transmitter has the standard configuration (i.e., no remote interface PWB), connect the shielded cable to pins 19 and 20 on the REMOTE I/O-A 25-pin male D-sub connector (A1J2A) on the rear panel of the controller (A4).
  9. For web based control of the transmitter, route an Ethernet (shielded Cat5) cable to one of the following locations:
    - ❖ If your transmitter has the optional remote interface PWB, route the Ethernet cable to the right-hand edge of the remote interface PWB. Connect the Ethernet cable to the LAN connector (J1) (see [Figure 2.8.2 on page 2.8.4](#)).
    - ❖ If your transmitter has the standard configuration (i.e., no remote interface PWB), route the Ethernet cable to the rear panel of the controller (A4), accessible from the rear of the transmitter. Connect the Ethernet cable to the LAN (A1J8A) connector (see [Figure 2.8.3 on page 2.8.5](#)).
  10. Re-install the rear filter panel, removed in Section 2.2, using its 14 1/4-turn latches (see [Figure 2.2.1 on page 2.2.3](#)).

Figure 2.8.2: Remote Interface PWB Connections

\*\* EACH REMOTE CONTROL/MONITOR ENTRY HOLE HAS A REMOVEABLE PLATE WITH A PRE CUT 1/4-INCH DIA HOLE. USE A CHASSIS PUNCH TOOL (e.g., GREENLEE) TO CREATE DESIRED HOLE SIZE IN THE PLATE(S). REMOVE EACH PLATE (FOUR M4 SCREWS) BEFORE PUNCHING. REMOVE THE PLATE TO ACCESS A 2.5-INCH HOLE, IF NECESSARY.

**REMOTE CONTROL/  
MONITOR ENTRY OPTIONS\*\***

Use front holes (right hole preferred) for remote interface PWB connections (including LAN), if used. Use rear hole for controller connections (including LAN) if remote interface PWB is not installed.

CUSTOMER  
ALARM/STATUS  
TERMINAL BLOCK  
TB2 (26 terminals)

CUSTOMER  
CONTROL  
TERMINAL BLOCK  
TB3 (26 terminals)

EXTERNAL  
INTERLOCK  
TB1 (terminals  
1 and 2)

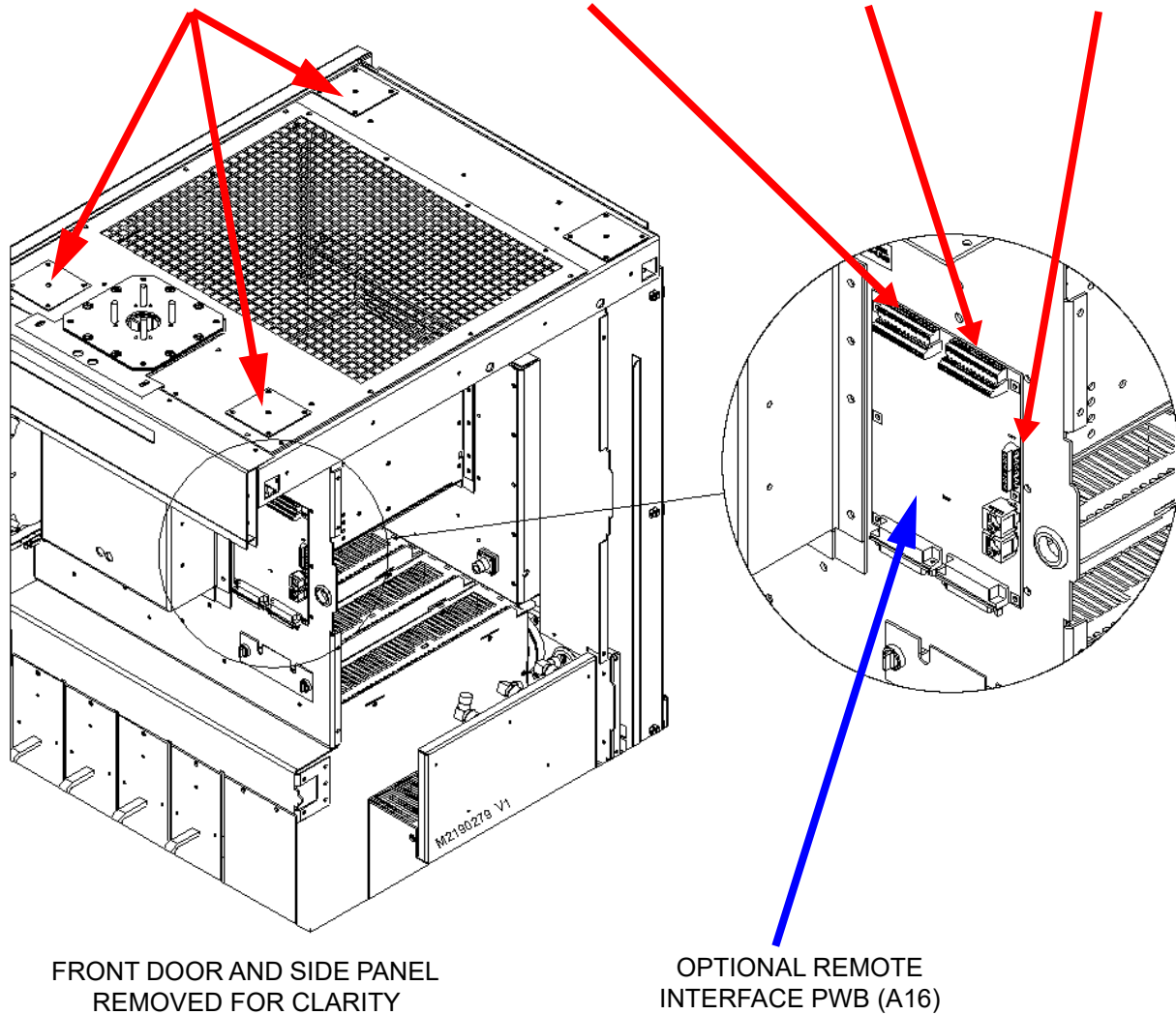
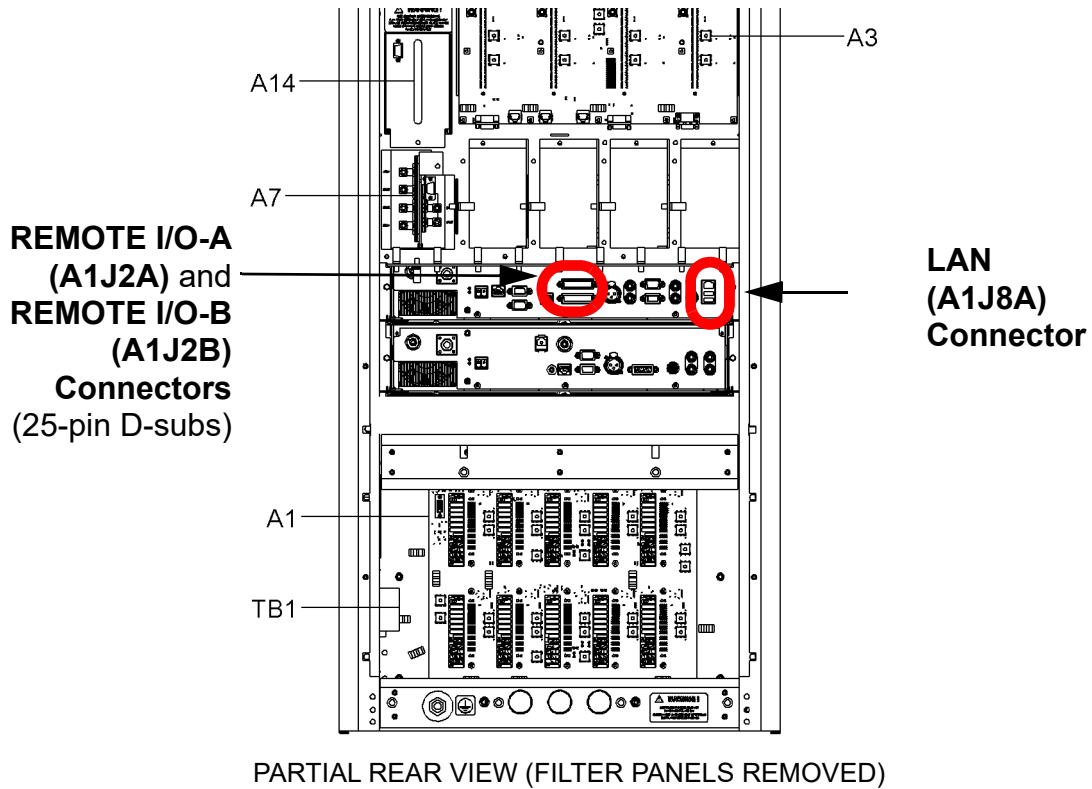

Figure 2.8.3: Controller Remote and LAN Connection





---

## SECTION 2.9: COMMISSIONING

**WARNING!** Before applying ac power and turning on the transmitter, you must customize some circuits to the station's power source and operating requirements. Do not perform this pre-commissioning unless you are a station engineer or a competent electronics technician.

The transmitter contains solid-state devices that may be damaged if subjected to excessive heat or high-voltage transients. Ensure that circuits are not overdriven or disconnected from their loads while turned on.

The transmitter was precisely calibrated and tested during manufacturing. Do not change any adjustments other than those specified.

This section contains the following procedures:

- [Pre-Commissioning Tasks - see page 2.9.2](#)
- [Commissioning - see page 2.9.3](#)
  - [Turning on the Transmitter - see page 2.9.3](#)
  - [Going On-Air - see page 2.9.8](#)
- [Network Setup - see page 2.9.9](#)
- [Configuring an External UPS - see page 2.9.11](#)

---

## Pre-Commissioning Tasks

1. Terminate the transmitter's RF output into a precision, 50  $\Omega$ , resistive dummy load that is adequately rated for the maximum expected total power output.
2. Verify that all panels are installed, and that their attaching hardware is firmly tightened.
3. Verify all program inputs are connected to the back of the controller and optional exciter.

**WARNING! If a jumper is placed between the INTLK inputs [pins 19 and 20 of the controller's REMOTE I/O-A connector (A1J2A) or TB1-1 and 2 on the optional remote interface PWB], safety features controlled by the external interlocks will be disabled. A fail-safe method of alerting personnel to this fact should be implemented. Voltages which are dangerous to life will be present on the RF output stages and the antenna system if the transmitter is turned on.**

4. Close the external interlock (if installed). If an external interlock is not installed, simulate the closing of the external interlocks by applying a short circuit between TB1-1 and TB1-2 of the optional remote interface PWB (A16), if installed. If the remote interface PWB is not installed, apply a short circuit between pins 19 and 20 of the REMOTE I/O-A (A1J2A) connector on the rear of the controller (A4).

**NOTE:** An interlock jumper (Nautel Part # 211-5060) is provided in the NV5LT/NV3.5LT's ancillary kit. It is intended to plug directly into the REMOTE I/O-A (A1J2A) connector (pins 19 and 20), on the rear of the controller module (A4) or into the INTLK inputs (TB1-1 and 2), on the optional remote interface PWB (A16), if installed. This jumper cannot be used if you are using a D-sub connector to make other remote I/O connections. Instead, you must solder a jumper between pins 19 and 20 of the mating connector (Nautel Part # JS28, also provided in the ancillary kit).

5. Set the switch on the front of each RF power module to its ENABLE position.



---

## Commissioning

**NOTE:** The following procedures require the use of the transmitter's front panel UI. If you require assistance to navigate the front panel UI, refer to the NV5LT/NV3.5LT Operations & Maintenance Manual for more information.

### Turning on the Transmitter

1. Switch on the ac power at the service entrance to turn on the transmitter. Confirm the ac voltage, noting the CSA label on the back of the transmitter.
2. Follow the instructions on the front panel display (see [Figure 2.9.1 on page 2.9.4](#)) to perform the first-time setup of the NV5LT/NV3.5LT, including selecting the frequency, output power and audio source.
3. When selecting the audio source from the initial start-up screens, there are four options - AES, MPX, Analog L/R and Audio Player. Use the up and down arrows to toggle between source options, then press the checkmark button to select the desired source. Continue to the next associated audio screens, noting they are different depending on the audio source type (see [Figure 2.9.2 on page 2.9.5](#) or [Figure 2.9.3 on page 2.9.6](#)). Edit values using the up and down arrows, and select using the checkmark button. Press the X button to cancel a selection.
4. When the audio setup in [Step 3](#) is complete, the front panel should display a setup completion screen (see [Figure 2.9.4 on page 2.9.6](#)). Press the cancel (X) button to go back to the editing screens. Press the checkmark button to finish the setup, which creates a new preset for the NV5LT/NV3.5LT (preset 1 or P1). The top level screen (see [Figure 2.9.5 on page 2.9.7](#)) will be displayed.

Figure 2.9.1: First Time Setup Initial Screens

	<p><b>SET FREQUENCY</b>          Press up/down arrows to adjust. Defaults to 98.1 MHz. Press checkmark to save and continue. Press X to cancel.</p>
	<p><b>SET OUTPUT POWER</b>          Press up/down arrows to adjust. Defaults to minimum power level. Press checkmark to save and continue. Press X to cancel.</p>
	<p><b>SELECT AUDIO SOURCE</b>          Press up/down arrows to select AES, MPX, Analog L/R or Audio Player. Press checkmark to save and continue (see <a href="#">Figure 2.9.2 on page 2.9.5</a> or <a href="#">Figure 2.9.3 on page 2.9.6</a>). Press X to cancel.</p>

Figure 2.9.2: Audio Setup Screens (AES or MPX)

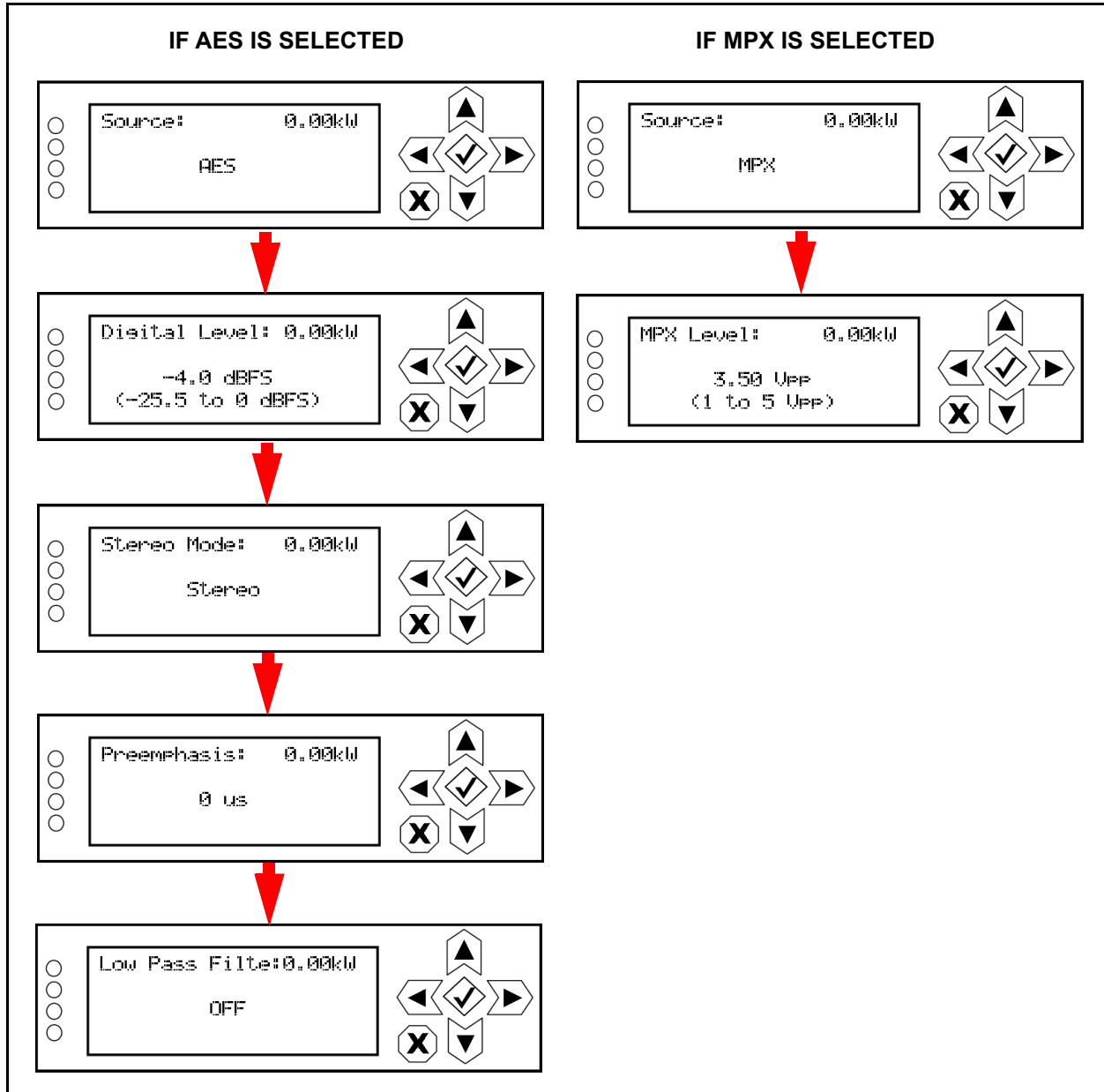

Figure 2.9.3: Audio Setup Screens (Analog L/R or Audio Player)

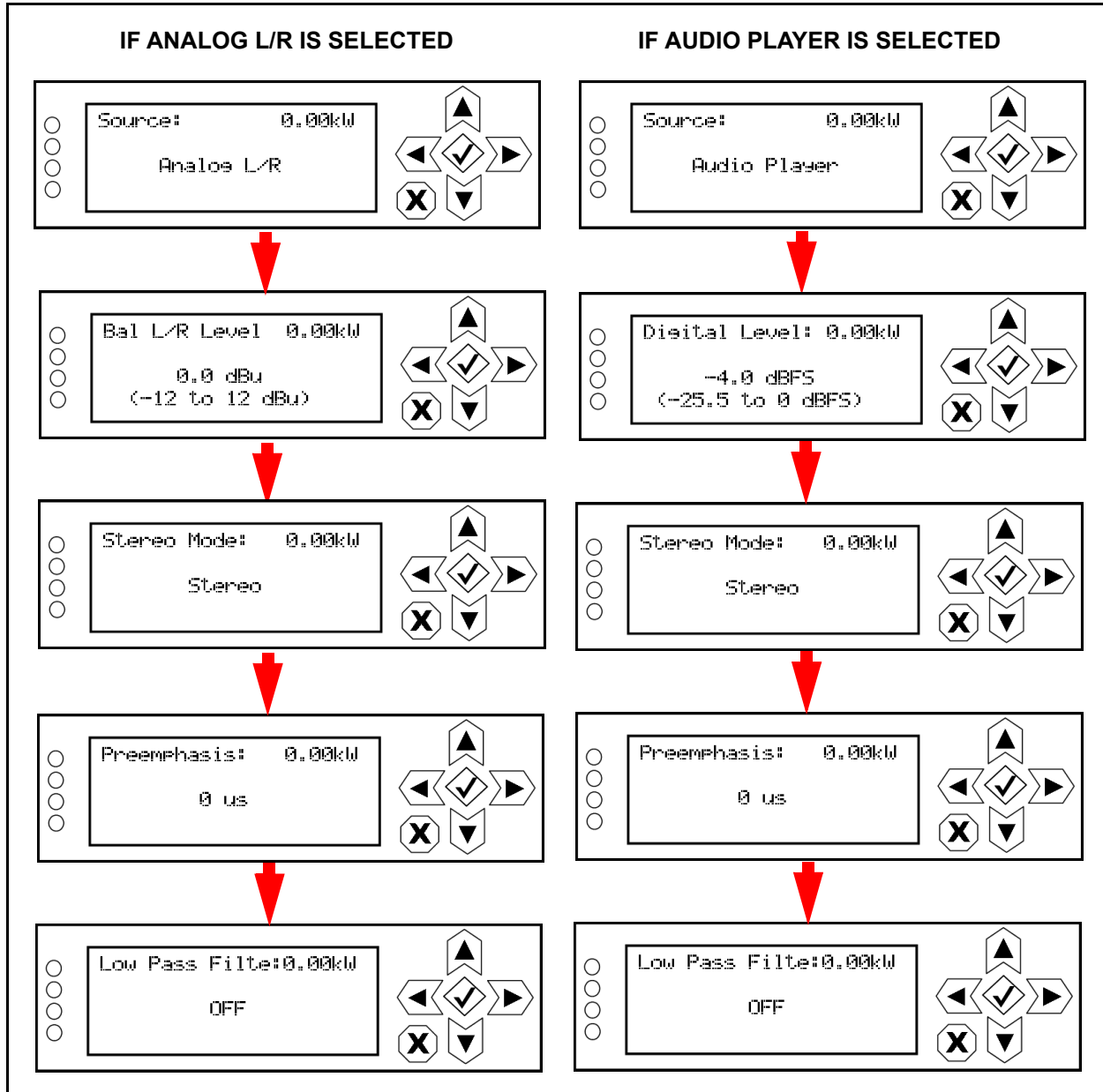

Figure 2.9.4: First Time Setup Completion Screen

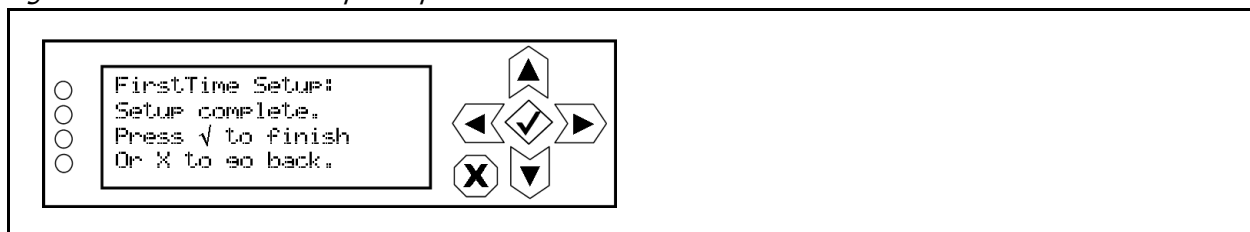
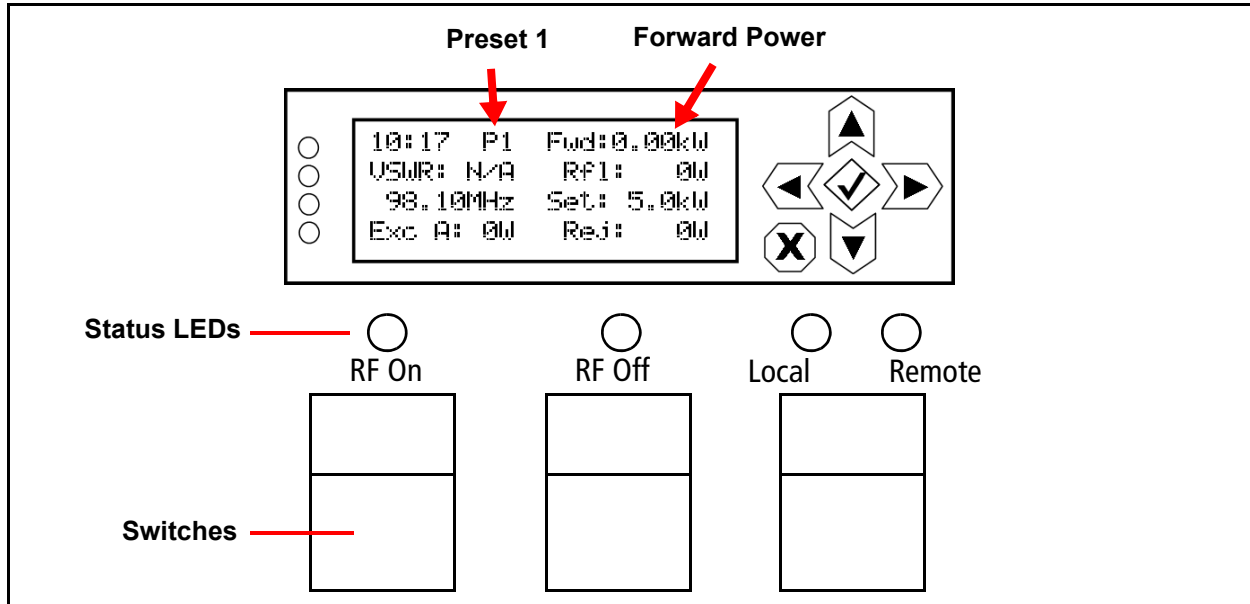

Figure 2.9.5: Front Panel User Interface



- In local mode (Local LED will be amber, see [Figure 2.9.5](#)), enable the NV5LT/NV3.5LT’s RF output by pressing the RF On switch (see [Figure 2.9.5](#)). The RF On status LED should turn amber, indicating RF power is enabled. The NV5LT/NV3.5LT should be operating at the output power level set during the initial setup.
- If you have the dual exciter option, make sure the transmitter’s front panel UI has been configured as detailed in [“Upgrading to Dual Exciter”](#) on [page 2.3.5](#). See the NV5LT/NV3.5LT Operations & Maintenance Manual for detailed information.
- If you have the dual LVPS option, make sure the transmitter’s front panel UI has been configured as detailed in [“Upgrading to Dual LVPS”](#) on [page 2.3.6](#). See the NV5LT/NV3.5LT Operations & Maintenance Manual for detailed information.
- Check the four LEDs on the left-hand side of the front panel display. They should all be green, indicating normal operation. If not, check for alarms by navigating to the front panel’s Main Menu -> View Status -> View Alarms screen. See the NV5LT/NV3.5LT Operations & Maintenance Manual or the NV5LT/NV3.5LT Troubleshooting Manual for detailed information.
- Set the correct time and date on the front panel by navigating to the front panel’s Main Menu -> User Settings-> Set Clock screen. See the NV5LT/NV3.5LT Operations & Maintenance Manual.

---

## Going On-Air

**WARNING!** If a jumper is placed between the INTLK inputs [pins 19 and 20 of the controller's REMOTE I/O-A connector (A1J2A) or TB1-1 and 2 on the optional remote interface PWB], safety features controlled by the external interlocks will be disabled. A fail-safe method of alerting personnel to this fact should be implemented. Voltages which are dangerous to life will be present on the RF output stages and the antenna system if the transmitter is turned on.

**IMPORTANT!** Before going on the air, if you want the safety interlocks to operate properly, the shorting jumpers installed in "[Pre-Commissioning Tasks](#)" on page 2.9.2, [Step 4](#) should be removed.

1. Turn off the power using the ac disconnect switch, if one is being used, or else at the ac source.
2. Connect the transmitter's RF output to an antenna system (or verify that the current connection is intact).
3. Turn the transmitter's ac power back on.
4. Use the front panel UI to begin transmitter operations. For detailed instructions, refer to the NV5LT/NV3.5LT Operating and Maintenance Manual.
  - ❖ Set for desired power level.
  - ❖ Press the front panel's RF On pushbutton switch.
  - ❖ Select the desired exciter as main, if applicable.

---

## Network Setup

If you wish to remotely control the transmitter via a network or directly through a laptop, configure your network parameters as follows:

1. Verify that the networking (DHCP on or off) decisions outlined in [Section 2, "Pre-installation tasks"](#) of the Pre-Installation Manual have been made. To use DHCP, you must have a visible DHCP server on your network. If you are not planning to use DHCP (i.e., your network does not have a DHCP server), you must obtain an IP address and netmask from your network administrator as well as gateway and nameserver(s) as applicable.
2. From the front panel UI, go the Main Menu -> User Settings -> Network Settings screen (see [Figure 2.9.6 on page 2.9.10](#)).
3. Ensure your network or laptop is connected to the LAN (A1J8A) connector on the rear of the controller (A4) or to the LAN connector (J1) on the optional remote interface PWB, if installed (see [Section 2.8, "Installing Control/Monitor Wiring"](#)).
4. If your network has a DHCP server and DHCP is set to ON (factory default), IP addresses will be automatically assigned. Verify this has occurred by viewing the IP Address and Netmask address sub-menus (Gateway and Nameserver addresses are optional; view as applicable). The MAC Address field cannot be modified.
5. If your network does not have a DHCP server or you wish to assign static IP addresses (i.e., direct connection with a laptop), set DHCP to OFF. Enter the appropriate addresses in the IP Address, Netmask, Gateway and Nameserver sub-menus, as applicable.

**NOTE:** Refer to ["Network Setup" on page 3.2.85](#) of the Operations and Maintenance Manual for more information.

6. Once you have established an IP address, you can login to the NV5LT/NV3.5LT's advanced user interface (AUI), which allows you to remotely control and monitor the NV5LT/NV3.5LT. See the ["Operating the Transmitter"](#) section of the Operations and Maintenance Manual for detailed AUI information.

Figure 2.9.6: Network Settings screens

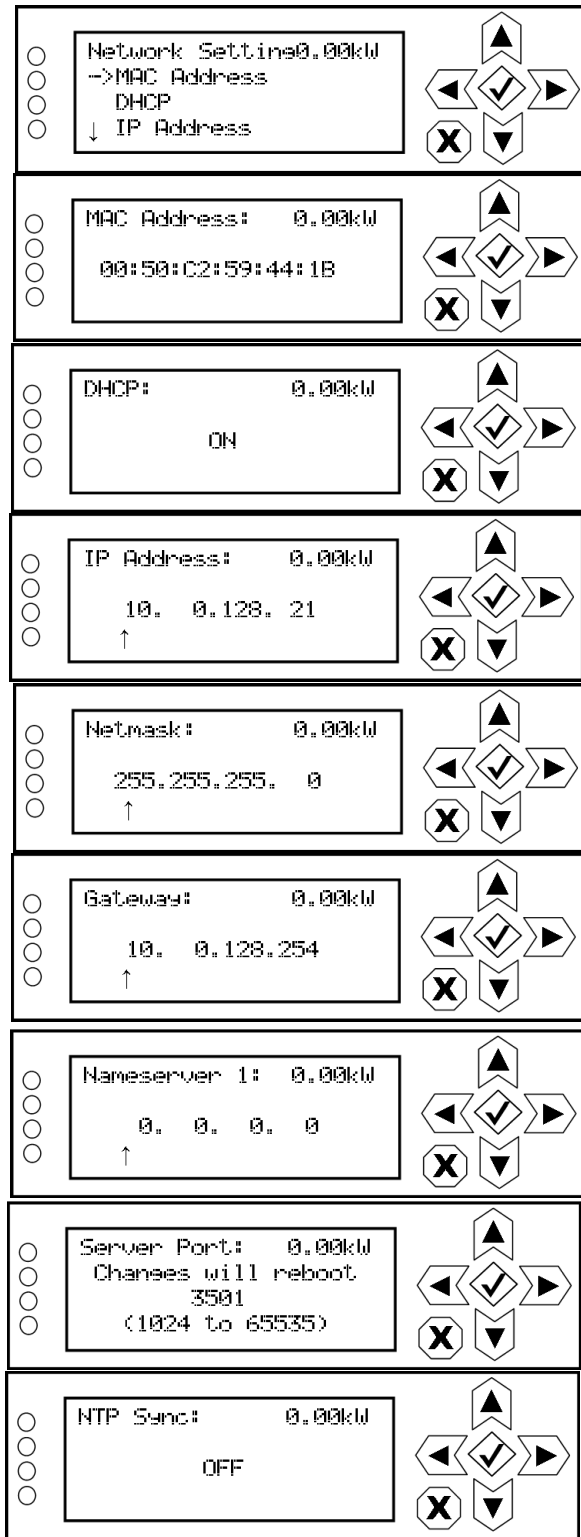

All addresses shown are for reference purposes only

Set during factory testing; cannot be modified

Set to ON if your network has a DHCP server. Automatically assigns IP, netmask, gateway and nameservers. Set to OFF if you do not have a DHCP server or if you wish to assign static addresses.

Specify the IP address. Consult with your network administrator.

Typical netmask address shown. Consult with your network administrator.

Specify the gateway address. Consult with your network administrator.

Specify a nameserver (or DNS) to enable the use of host names. If no nameserver is entered, only direct IP addresses can be used to configure the email server and any live streams such as Livewire or Shoutcast.

Specify the AUI port # for port forwarding. 3501 is the default port number.

NTP = Network Time Protocol. Set to ON to allow the network to synchronize to the transmitter time. Set to OFF to use the transmitter's internal time reference.



## Configuring an External UPS

If the UPS Interface option was installed, perform the following steps to configure the transmitter to recognize the external UPS.

To view the **UPS Installed** screen, select **System Settings > HW Config > UPS Installed** from the Main Menu. Set to **"YES"**.



---

## SECTION 2.10: PARTS AND TOOLS

This section describes parts associated with the NV5LT/NV3.5LT transmitter, and tools needed during installation and routine operation. Topics include:

- [Parts Supplied by Nautel - see page 2.10.2](#)
- [Parts Not Supplied by Nautel - see page 2.10.2](#)
- [Parts Ordering - see page 2.10.2](#)
- [Module Exchange Program - see page 2.10.3](#)
- [Tools for Installation - see page 2.10.3](#)

### Contacting Nautel

You can reach Nautel to order parts or for technical assistance at:

Nautel Limited  
10089 Peggy's Cove Road  
Hackett's Cove, NS Canada B3Z 3J4  
Phone: +1.877.628.8353 (Canada/US)  
+1.902.823.5100 (International)

Fax: +1.902.823.3183

Email: [support@nautel.com](mailto:support@nautel.com)

Web: [www.nautel.com](http://www.nautel.com)

## Parts Supplied by Nautel

### Ancillary Parts Kit

An ancillary parts kit is shipped with the NV5LT/NV3.5LT. This kit contains items needed during the installation process. The kit includes toroids, spare fuses, screws and miscellaneous hardware.

### Documentation

See “NV5LT/NV3.5LT Transmitter Manuals” in the “About this Manual” section of the Pre-Installation Manual.

## Parts Not Supplied by Nautel

Some parts and materials required to complete installation are not supplied by Nautel. The parts you need vary with the installation requirements. The list of parts you normally provide yourself during installation include:

- A suitable 50  $\Omega$  RF output coaxial cable, terminated by the proper connector (e.g., field flange), complete with center male connector (e.g., bullet) at the transmitter end.
- All external control and monitor wiring, including the associated terminating devices, conduit and conduit clamps.
- All electrical power cables, including conduit, terminating devices, and conduit clamps.
- Special tools, if required (e.g., torque wrench).

## Parts Ordering

You can order replacement parts from the Customer Service Department, or directly from Nautel through the Nautel website.

## Module Exchange Program

Nautel offers a module exchange program for customers who require expedited servicing and replacement of faulty modules. The module exchange program provides immediate replacement of failed modules with refurbished modules.

- The replacement module is shipped to the customer as soon as the customer reports the failure. The customer then returns the failed module to Nautel using the same shipping package.

## Tools for Installation

The tools you need during transmitter installation include the following:

- Digital voltmeter (recommend 1000 V, CAT-III rating)
- Phillips screwdrivers, sizes #1 and #2
- Pliers
- Wire cutters
- Panel punch (Greenlee, etc.) for suitable size cable entry hole, as desired
- Hex wrenches (Allen keys)
- Torque wrench with hex adapter, capable of 500120 in-lbs (56.513.6 N-m) (for ac input terminal block)
- Metric and Imperial socket set up to 24 mm (15/16 inch)
- Metric and Imperial wrench set up to 25 mm (1 inch)
- Electrician's knife



---

## SECTION 2.11: PRE-INSTALLATION / INSTALLATION ASSISTANCE

Nautel provides a number of support options to help you during pre-installation planning and preparation:

- [Pre-Installation Consulting](#)
- [Installation and Commissioning Service](#)
- [Online Documentation](#) - see page 2.11.2
- [On-Site Support](#) - see page 2.11.3
- [Training](#) - see page 2.11.3
- [Standard Warranty](#) - see page 2.11.4
- [Extended Warranties](#) - see page 2.11.7

### Pre-Installation Consulting

Nautel field support specialists are available to answer questions and work with you to ensure that your site will be ready for the installation of your NV5LT/NV3.5LT transmitter. For support, contact Nautel Customer Service and request assistance ([“On-Site Support”](#) on page 2.11.3).

### Installation and Commissioning Service

Nautel offers an installation and commissioning service to customers who want assistance with configuring and commissioning a new Nautel transmitter. After the customer completes the transmitter assembly and installation, Nautel technical personnel will spend up to three days on-site to help make the ac power, RF and remote connections, and to assist with the configuration and testing of Nautel equipment.

The customer is responsible for ensuring that the following stages of installation have been completed, prior to the arrival of Nautel personnel:

- Ac power wiring for the transmitter has been installed and connected at the transmitter and at the breaker panel or the building’s service entrance.

- 
- The customer has prepared the RF coaxial cable – used to connect the transmitter to the antenna – and installed the required connector. The customer has also installed the RF coaxial cable in place and connected it to the antenna, while leaving the transmitter end of the cable unconnected.
  - Where required, all remote control and monitoring cables have been installed and connected to the station equipment (e.g., modulation monitor, frequency monitor, and power meter).
  - The site has been made ready for the equipment, and adequate protection against lightning and lightning-induced transients has been provided.
  - The transmitter has been unpacked, closely checked for any damage caused by shipping, and then assembled.
  - The following test equipment has been made available at the site:
    - ❖ Two-channel oscilloscope (with probes)
    - ❖ Audio signal generator
    - ❖ Distortion analyzer
    - ❖ Spectrum analyzer
    - ❖ Modulation monitor
    - ❖ Frequency counter
    - ❖ 50  $\Omega$  test load (rated for 150% of carrier power, VSWR less than 1.1:1)

Nautel's service representative takes full responsibility for commissioning the transmitter, validating all external interfaces (i.e., the ac supply, RF output, remote control and monitoring equipment) and checking out the equipment prior to activation. The service representative turns on the transmitter, performs all adjustments and set-up procedures, and carries out proof of performance tests at the site. These tests ensure that the transmitter is operating normally in compliance with its specifications. The service representative also provides a demonstration and a short explanation of the operation of the transmitter. Finally, the customer signs an Acceptance of Installation Certificate that provides feedback to Nautel regarding the commissioning service.

## Online Documentation

Nautel provides documentation online to customers, letting you familiarize yourself with specifications, operation, maintenance and troubleshooting prior to the delivery of your equipment.

- Documentation is also provided on USB and delivered with the transmitter.



## On-Site Support

If you require on-site assistance, Nautel's field support specialists can help you prepare your site and ensure that your NV5LT/NV3.5LT transmitter installation can proceed as quickly as possible. For more information about on-site support, including scheduling and pricing, contact Nautel Customer Service:

- Telephone: +1.902.823.5100
- Fax: +1.902.823.3183
- Email: [support@nautel.com](mailto:support@nautel.com)

After business hours (Atlantic time or Eastern time in North America), requests sent by fax or email will be acknowledged within one working day.

## Training

Nautel's SBE-certified broadcast training programs satisfy your day-to-day knowledge requirements. Students participating in Nautel's broadcast transmitter or RF basics training programs earn one SBE credit for each completed day of training.

Nautel's comprehensive selection of training programs will help customer staff develop valuable skill sets, reduce downtime, and make the most of the customer's technology investment.

Nautel training programs are made up of individual modules that can be 'mixed and matched' to meet the customer's specific training needs. All Nautel training courses are available at the Nautel Training Centre. Training can also be provided at the customer's facility, and training the customer's technical staff on the customer's transmitter.

All training courses at the Nautel Training Centre combine classroom and hands-on laboratory work to ensure a balanced learning experience.

Nautel training courses feature:

- Limited class sizes to ensure maximum student participation and access to equipment
- Emphasis on need-to-know, day-to-day knowledge
- Labs that focus on the tasks most often performed at the transmitter site

Many of our classes also include diagnostic lab exercises.

---

## Standard Warranty

Nautel guarantees all mechanical and electrical parts of Nautel Transmitters for a period of forty-eight months, and all other Nautel manufactured equipment (including Importers and Exporters) for a period of twelve months from date of shipment, provided the equipment has been installed, operated and maintained in accordance with Nautel's recommendations, and the equipment has not been misused, neglected or modified. Nautel's liability is limited, at the absolute discretion of Nautel, to repairing or replacing returned equipment that to the satisfaction of Nautel has been found defective.

Warranty for third-party items is provided by the Original Equipment Manufacturer. Exercise of such warranty shall be between the Buyer and the Third-Party.

1. Properly qualified technical personnel must install, maintain, and repair the equipment in accordance with Nautel recommendations and good engineering practice.
2. A "Part Failure" shall be deemed to have occurred when the part has become defective, or does not have the characteristics required for the specified equipment performance:
  - a. when the equipment is operated within the design parameters, and
  - b. when the equipment is installed and adjusted according to Nautel's prescribed procedures as stated in the instruction manual.
3. Nautel shall provide replacements for all "Parts" to the Buyer when they become defective during the warranty period, and upon the return of the defective part. Replacement parts warranty to be 90 days or end of original warranty; whichever comes first.
4. If the Buyer receives a replacement module, as part of Nautel's module exchange program, the old module must be returned to Nautel within 45 days of receipt of the new module, at the buyers expense. If the old module is not received after 45 days, the customer will be invoiced. The buyer is responsible for installing the replacement/repaired module in the transmitter.
5. In the event that a "Part" fails during the warranty period and causes damage to a subassembly which cannot be readily repaired in the field, the entire subassembly so damaged may be returned to Nautel for repair. The repairs will be made without charge to the Buyer.
6. Written authorization must be obtained before returning any equipment or goods for any reason. Equipment or goods returned under this warranty shall be delivered to Nautel's premises at the Buyer's expense. Where no-charge warranty replacements or repairs are provided under items 2, 3, 4, or 5, Nautel will pay that part of the shipping costs incurred in returning the part/assembly to the Buyer. Note: the Buyer is responsible for any and all import fees, duties or taxes.

7. Nautel does not warrant or guarantee, and will not be liable for:
  - a. defects or failures caused in whole or in part by abuse, misuse, unauthorized repair attempts, unauthorized alteration or modification of the equipment;
  - b. equipment built to customer specifications that is later found not to meet customer needs or expectation;
  - c. performance of equipment when it is used in combination with other equipment not purchased, specified, or approved by Nautel;
  - d. damages and performance limitations due to outside forces such as lightning, excessive heat or cold, excessive ac surges or high corrosive environments;
  - e. changes made by personnel other than Nautel authorized personnel, including charges incurred; and
  - f. for any costs for labor performed by the customer without Nautel's prior written approval.
8. Nautel does not warrant that software:
  - a. is free of errors, bugs or defects;
  - b. will be compatible with third party software;
  - c. results, output or data provided through or generated by the software are accurate, complete, or reliable; and
  - d. errors found will be corrected.
9. Nautel shall have the right and shall be provided full access to investigate whether failures have been caused by factors beyond its control.
10. In no event shall Nautel be liable for any consequential damages arising from the use of this equipment.
11. This warranty is in lieu of all other express warranties of Nautel, whether express or implied, and Nautel does not assume, nor is any other person authorized to assume on Nautel's behalf, any other obligation or liability.
12. Third party items ordered, the guarantee/warranty of these items will be from the manufacturer of these items. Exercise of such warranty shall be between the Buyer and the third party provider.
13. Nautel provides telephone and email support for its products for the life of the product at no charge. After the warranty period, parts and on-site support for the equipment are offered at a rate to be determined upon request.

## Technical Assistance

Nautel's field service department provides telephone technical assistance on a 24 hour, seven days a week basis. Requests by other media (fax or e-mail) will be responded to the next working day if received after Nautel's normal working hours. Contact the appropriate field service centre:

Nautel Limited  
10089 Peggy's Cove Road  
Hackett's Cove, NS Canada B3Z 3J4  
Phone: +1.902.823.3900 or  
Toll Free: +1.877.6NAUTEL (6628835) (Canada & USA only)  
Fax: +1.902.823.3183

Nautel Inc.  
201 Target Industrial Circle  
Bangor, Maine USA 04401  
Phone: +1.207.947.8200  
Fax: +1.207.947.3693

Customer Service (24 hour support)  
+1.877.628.8353 (Canada & USA only)

+1.902.823.5100 (International)

Email: [support@nautel.com](mailto:support@nautel.com)  
Web: [www.nautel.com](http://www.nautel.com)

## Module Exchange Service

In order to provide Nautel customers with a fast and efficient service in the event of a problem, Nautel provides - for North American customers only - a factory rebuilt, module exchange service which takes full advantage of the high degree of module redundancy in Nautel equipment.

For complete details on this service, see <http://support.nautel.com/policies/repairs-exchange/>

## Extended Warranties

Nautel's standard four-year warranty provides excellent coverage and satisfies most customers' needs. However, if you want extended coverage, Nautel offers one and two-year Extended Warranty Plans to cover electrical and mechanical repairs or replacements for all Nautel equipment.

### Coverage

The Extended Warranty Plan includes:

- A module exchange program for many common modules and circuit boards (North America only)
- Toll-free hotline (North America only)
- Necessary labor performed by Nautel authorized personnel to repair the product back to factory specifications
- Necessary components
- Modifications to correct performance problems
- Return shipping

### Details

Extended Warranty Plans must be purchased prior to the expiration of original four-year warranty.

One-year Extended Warranty Plans add an additional year (12 months) of coverage after the end of the customer's standard four-year warranty. The two-year plan adds an additional two years (24 months).

Only repairs done at Nautel's facilities or by Nautel authorized personnel will be covered by the Extended Warranty Plans.

You must ship faulty products back to Nautel, prepaid, and in the original package or in a package that provides equivalent protection.

Nautel can choose to repair or replace equipment.

## Purchasing a One or Two-Year Extended Warranty Plan

If the transmitter is still covered by its original four-year warranty period, you can contact Nautel by telephone, fax, mail, or email with the model number, serial number and date of purchase.

Once you purchase a Nautel Extended Warranty Plan, you receive an extended warranty plan certificate, plan number, and a toll-free number (North America only) to call for any service-related issues.

## Using the Extended Warranty Plan

Contact Nautel's Canadian or U.S. service facility by phone, fax, or email as soon as a problem occurs. The following will be required when contacting Nautel:

- Extended warranty plan number
- Product model number
- Serial number
- Brief description of the problem

If Nautel's service technicians are unable to solve the problem over the telephone, Nautel will give you an RMA number. You then return the module or circuit board to a Nautel service facility so that Nautel can provide a replacement. Do not ship a component back to Nautel until you have an RMA number.

---

## SECTION 2.12: LIST OF TERMS

This section defines some of the terms that are used in Nautel documentation.

**AES/EBU.** Audio Engineering Society/European Broadcasting Union (AES/EBU) is the name of a digital audio transfer standard. The AES/EBU digital interface is usually implemented using 3-pin XLR connectors (the same type connector used in professional micros). One cable carries both left-channel and right-channel audio data to the receiving device.

**AUI.** The Advanced User Interface is the local touch screen on the front door and the advanced remote control/monitoring feature that allows for extensive remote control and monitoring of the transmitter.

**CUTBACK.** A reduction in RF output power, caused by the occurrence of multiple shutbacks within a pre-defined period.

**DHCP.** Dynamic Host Carrier Protocol.

**DSP.** Digital Signal Processing.

**EEPROM.** Electrically Erasable Programmable Read-Only Memory.

**FOLDBACK.** A reduction in RF output power, caused by adverse load conditions (high VSWR). No shutbacks or cutbacks have occurred.

**LED.** Light Emitting Diode (also referred to as lamp).

**LVPS.** Low Voltage Power Supply. A module or modules used in the ac-dc power stage that generates the low level dc supply voltage for the transmitter.

**PRESET.** A setting that controls power level, frequency and audio parameters. The NV5LT/NV3.5LT allows you to pre-program multiple presets.

**PWB.** Printed Wiring Board.

**SHUTBACK.** A complete, but temporary loss of RF output power, caused by any one of a variety of faults, including high VSWR, high reject load power, RF drive failure, or an open external interlock.

**SHUTDOWN.** A complete and permanent loss of RF output power. Typically follows repeated cutback, foldback or shutback events.

**SURGE PROTECTION PANEL.** An electrical panel that protects equipment from electrical surges in the ac power supply, antenna or site ground caused by lightning strikes.

**UI.** The User Interface is the controller module's front panel LCD screen that allows for extensive local control and monitoring of the transmitter.

**VSWR.** Voltage standing wave ratio. This is an expression of the ratio of reverse voltage to forward voltage on the feedline and antenna system. An ideal VSWR of 1:1 provides maximum transmitter-antenna efficiency.







## NV5LT/NV3.5LT INSTALLATION MANUAL

Document: NHB-NV3.5LT-NV5LT-INS

Issue: 2024-05-01

### **Nautel Limited**

10089 Peggy's Cove Road  
Hackett's Cove, NS Canada B3Z 3J4

Toll Free: +1.877.6NAUTEL (662.8835)  
(Canada & USA only) or

Phone: +1.902.823.3900 or

Fax: +1.902.823.3183

### **Nautel Inc.**

201 Target Industrial Circle  
Bangor, Maine USA 04401

Phone: +1.207.947.8200

Fax: +1.207.947.3693

### **Customer Service (24-hour support)**

+1.877.628.8353 (Canada & USA only)

+1.902.823.5100 (International)

Email: [support@nautel.com](mailto:support@nautel.com)

Web: [www.nautel.com](http://www.nautel.com)

© Copyright 2024 NAUTEL. All rights reserved.

