



1: PRE-INSTALLATION MANUAL

NV20LT/NV15LT TRANSMITTER

Document ID:	NHB-NV15LT-NV20LT-PRE
Version:	6.0
Issue Date:	2024-05-01
Status:	Standard



Contact Information

Nautel Limited

10089 Peggy's Cove Road
Hackett's Cove, NS Canada B3Z 3J4

Toll Free: +1.877.6NAUTEL (662.8835)
(Canada & USA only) or

Phone: +1.902.823.3900 or

Fax: +1.902.823.3183

Nautel Inc.

201 Target Industrial Circle
Bangor, Maine USA 04401

Phone: +1.207.947.8200

Fax: +1.207.947.3693

Customer Service (24-hour support)

+1.877.628.8353 (Canada & USA only)

+1.902.823.5100 (International)

Email: support@nautel.com

Web: www.nautel.com

The comparisons and other information provided in this document have been prepared in good faith based on publicly available information. For verification of materials, the reader is encouraged to consult the respective manufacturer's most recent publication on the official website or through contact with Customer Service.

© Copyright 2024 NAUTEL. All rights reserved.

CONTENTS

Contact Information	1.iii
<hr/>	
RELEASE CONTROL RECORD	1.IX
<hr/>	
ABOUT THIS MANUAL	1.XI
Technical Support	1.xi
NV20LT/NV15LT Transmitter Manuals	1.xi
Nautel Website / Online Resources	1.xii
<hr/>	
ABOUT SAFETY	1.XV
Electrical Hazards	1.xv
Lightning Hazards	1.xvi
RF Hazards	1.xvi
Toxic Hazards	1.xvi
Physical Hazards	1.xvi
Other Hazards	1.xvi
<hr/>	
SAFETY PRECAUTIONS	1.XVII
Personal Safety	1.xvii
Site Safety	1.xviii
Equipment Safety	1.xx
<hr/>	
FCC SUPPLIER DECLARATION OF CONFORMITY	1.XXIII
<hr/>	
NOTICE ACCOMPANYING SALES	1.XXV
<hr/>	
DESCRIPTION	1.1.1
Capabilities	1.1.1
Standard Configuration and Options	1.1.3

PRE-INSTALLATION TASKS	1.2.1
Preparing for Installation	1.2.1
Selecting a Location for the Transmitter	1.2.4
Installing an Antenna Feedline	1.2.4
<hr/>	
PHYSICAL REQUIREMENTS	1.3.1
Dimensions	1.3.1
Clearances	1.3.6
Weight	1.3.6
<hr/>	
COOLING REQUIREMENTS	1.4.1
Air Flow in the Transmitter	1.4.1
Cooling	1.4.2
Heating	1.4.2
<hr/>	
ELECTRICAL REQUIREMENTS	1.5.1
Main Electrical Power	1.5.1
UPS Backup	1.5.4
Station Reference Ground	1.5.5
<hr/>	
RF OUTPUT REQUIREMENTS	1.6.1
Antenna Feed Cable	1.6.1
Antenna System	1.6.1
<hr/>	
PLANNING PROGRAM INPUTS	1.7.1
Analog Inputs	1.7.2
Digital Inputs	1.7.4
Other Features	1.7.5
<hr/>	
PLANNING FOR CONTROL AND MONITORING	1.8.1
Front Panel UI Control	1.8.1

Remote Control	1.8.1
Remote Inputs	1.8.4
Remote Outputs	1.8.8
Analog Outputs	1.8.11
Web Based Control	1.8.13
SNMP Control/Monitoring	1.8.14
Email Server	1.8.14
Nautel Phone Home	1.8.15
External Interlock	1.8.16

PARTS AND TOOLS	1.9.1
Contacting Nautel	1.9.1
Parts Supplied by Nautel	1.9.2
Parts Not Supplied by Nautel	1.9.2
Parts Ordering	1.9.2
Module Exchange Program	1.9.3
Tools for Installation	1.9.3

PRE-INSTALLATION ASSISTANCE	1.10.1
Pre-installation Consulting	1.10.1
Installation and Commissioning Service	1.10.1
Online Documentation	1.10.2
On-Site Support	1.10.3
Training	1.10.3
Extended Warranties	1.10.4

LIST OF TERMS	1.11.1
----------------------	---------------

Release Control Record

ISSUE	DATE	REASON
6.0	2024-05-01	Release 6 of NV20LT/NV15LT (NARF73F/01). Supports software version NVLT SW 5.0 and newer.

About This Manual

Technical Support

Nautel offers technical support to customers over the Internet and by telephone. Nautel's customer support team will answer your questions and work with you to identify and resolve problems.

For 24-hour technical support, call toll free at 1.877.628.8353 (in USA and Canada only) or call 1.902.823.5100 (international) or find us on the Internet at <http://www.nautel.com>.

For parts and tools information, see "Parts and Tools" on page 1.9.1 of the NV20LT/NV15LT Pre-Installation Manual.

For extended warranty information, see "Pre-installation assistance" on page 1.10.1 of the NV20LT/NV15LT Pre-Installation Manual.

NV20LT/NV15LT Transmitter Manuals

The NV20LT/NV15LT documentation suite includes the following documents:

Volume 1, NV20LT/NV15LT Pre-installation (PRE) Manual

Provides instructions and reference information needed when planning and preparing for the installation of the NV20LT/NV15LT transmitter.

Nautel Site Protection Manual

Provides detailed information about protecting your site from lightning-related hazards.

Volume 2, NV20LT/NV15LT Installation (INS) Manual

Provides instructions and reference information needed to install the NV20LT/NV15LT transmitter.

Volume 3, NV20LT/NV15LT Operating and Maintenance (OPS) Manual

Provides instructions for operating and maintaining the NV20LT/NV15LT transmitter.

Volume 4, NV20LT/NV15LT Troubleshooting (TRB) Manual

Provides instructions for troubleshooting the NV20LT/NV15LT transmitter and replacing its sub-assemblies. It also contains detailed technical information, including parts lists, wiring lists, electrical schematics and mechanical drawings.

Nautel Website / Online Resources

The Nautel website provides useful resources to keep you up to date on your NV20LT/NV15LT. Frequently asked questions (FAQ), How To Videos, latest software versions are just a few of the many resources available.

Nautel User Group (NUG)

The Nautel Support website allows access to product manuals and the RF Toolkit when you create a free NUG account (see Figure below).

Figure 1: Accessing the NUG

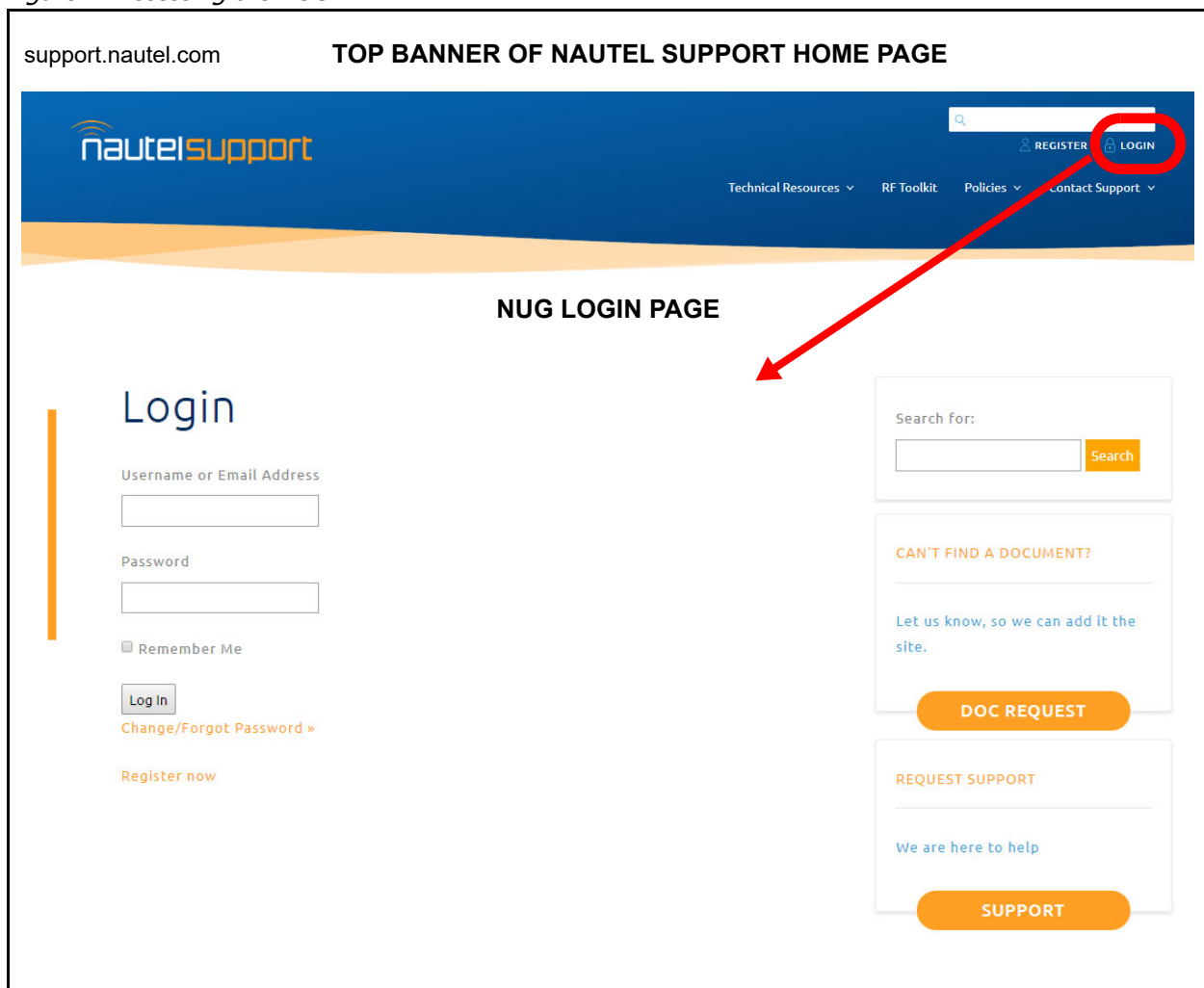

Online Documentation

The Technical Documentation section Of the Nautel Support website provides online access to all the documentation for your NV20LT/NV15LT. Documentation is provided in Acrobat (PDF) format. You can use the documentation online or print the sections that you need.

When using online documents:

- Click on blue text (hyperlinks) to jump to a related section, or to get additional information (e.g., view a term's definition).
- To search a document to find keywords, use Find in Acrobat Reader's Edit menu.
- To quickly find a specific section, click the section in the PDF file's Bookmarks list.

About Safety

All Nautel transmitters are designed to meet the requirements of EN60215, Safety Requirements for Radio Transmitters. The philosophy of EN60215 is that the removal of any cover or panel that can only be opened using a tool is a maintenance activity, and that any person performing a maintenance activity is expected to be trained for that activity. Under EN60215, it is assumed that trained personnel will be knowledgeable and will take precautions such as removing all power to the transmitter before accessing its components.

Electrical Hazards

To remove power from the transmitter, switch off and lock out the ac power. There are three amber LEDs at the bottom rear of each cabinet that glow to remind anyone who has not turned off the power that the system is live and serious danger is present.



DANGER - HIGH VOLTAGE

Indicates dangerous voltage (in excess of 72 volts), capable of causing a fatal electrical shock, are present on or near parts bearing this label.

WARNING: It is not enough to switch off RF power. The power line is still connected. Disconnect and lock out the upstream supply before servicing.

Mount the transmitter ac power disconnect switch/breaker close to the transmitter so that it can be reached quickly in an emergency. Clearly label the switch/breaker (e.g., EMERGENCY SWITCH).

After turning off the power, always perform a measurement to confirm that the power is off before touching anything within the transmitter. Confirm test equipment operates properly before and after the measurement is made. If the wrong breaker was opened, the equipment will be live.

WARNING: Do not use an ordinary multimeter to check for voltage, since it may have been left inadvertently on the AMP (A) range, triggering a short and an arc blast that could result in severe burns and even death.

Use only a non-contact voltage probe or a safety voltmeter (available from vendors such as Fluke, Ideal, and Teagam).

Use a proper lockout/tagout procedure to ensure that another worker cannot accidentally reapply power while you are performing maintenance on any part of the transmitter or site.

Lightning Hazards

Before opening the transmitter and touching internal parts, remove and solidly ground the antenna connection.

WARNING: It is not enough to ground the antenna terminal with the antenna still connected. Even a small impedance in the ground strap will result in lethal voltages during a lightning strike.

RF Hazards

A serious RF hazard and very high voltages exist in the vicinity of the antenna and its networks during normal operations.

Toxic Hazards

There may be devices or parts used in this equipment that contain beryllium oxide ceramic, which is non-hazardous during normal device operation and under normal device failure conditions. These devices are specifically identified with "(BeO)" in the Description column of the Troubleshooting Manual's parts list(s).

Do not cut, crush or grind these devices or parts because the resulting dust is hazardous if inhaled. Unserviceable devices should be disposed of as harmful waste.

Physical Hazards



DANGER - MOVING BLADES

Fan blades can cause injury. Lock out power before removing safety features.

Other Hazards

Ensure that appropriate fire alarms and fire extinguishers are available. Extinguishers must be suitable for use on electrical fires.

Many other site safety risks exist. It is beyond the scope of this manual to identify all the risks and procedures.

Safety Precautions

This section provides very important information about protecting the safety of personnel and equipment:

- [Personal Safety](#) - see page 1.xvii
- [Site Safety](#) - see page 1.xviii
- [Equipment Safety](#) - see page 1.xx

Personal Safety

Training

The training of any personnel who will have physical access to the site or the transmitter is very important. Personnel must be familiar with the transmitter, so that they can avoid physical danger, and be aware of hazards to themselves and the equipment.

Nautel offers a number of training courses covering the basic fundamentals of RF systems and transmitters, and the operation and maintenance of the transmitter. For more information about available courses and schedules, go to the Nautel website at <http://support.nautel.com/training/> or ask your Nautel sales representative.

Site Orientation

When you give personnel access to the transmitter site (e.g., hiring new personnel, or giving access keys to personnel), perform a site orientation to ensure that they are familiar with the site, on-site procedures, and on-site hazards. Cover the following topics:

- Securing the site (locking doors and fences) to prevent unauthorized access
- How and when to call for technical support or emergency assistance
- Areas of the site and pieces of equipment that are off limits

Voltage Awareness

Ensure that all personnel that are able to access areas with high voltage circuits or high field strengths are aware of the associated hazards. Cover the following topics:

- High voltage or high field strength areas where caution is required
- Physical risks of electric shock
- Risks for personnel with pacemakers or other medical implants
- Induced voltages in high field strength areas
- On-site risks during thunderstorms and lightning strikes
- Operation of safety interlocks (if installed)

First Aid

Nautel does not offer first aid training, since the hazards associated with high voltage and RF energy are not specific to the transmitter. However, the customer should provide first aid training to all personnel who have access to the transmitter site. First aid training should include CPR, care of burns, artificial respiration, and defibrillator if specific equipment is available on-site.

Site Safety

Controlling Access

Transmitters and antennas generate and carry dangerous voltages that can be harmful or fatal. It is very important that you control access to the site and its equipment. To secure your transmitter site, use:

- Locking steel or security doors to prevent casual access
- A perimeter fence to keep trespassers away from the antenna system and feedline
- "No Trespassing" signs
- An alarm system

Marking Hazards

Place warning signs close to any hazardous areas or systems (e.g., the feedline or the antenna system). Make the signs large enough that they cannot be missed. Provide signage in all languages used in the region. These signs are intended not only for authorized personnel, but also for emergency responders or accidental trespassers.

Qualifying Site Personnel

Make sure that personnel who have access to the site are qualified to work around electronics and high voltage systems.

Ac Power Protection

You should take steps to protect equipment from surges (over-voltage spikes) on the ac power lines. Surges may occur during thunderstorms, or because of malfunctions in the electrical distribution grid. Surge suppressors and ac power conditioners can prevent serious damage to your on-site equipment, including the transmitter.

RF Protection

Transmitters and their antenna systems create intense radio frequency fields at the transmitter site, particularly near the feedline, antenna and tower. At some sites, these fields may cause biological effects, including the heating of body tissues. Intense fields can also create dangerous high voltages on ungrounded, conductive surfaces and objects. At certain points where high voltage conductors come close to grounded conductors (e.g., at feedline junctions or on the tower), dangerous electrical arcing can occur. It is very important that you take the following steps to prevent damage to equipment or personnel due to RF fields:

- Use safety interlocks to de-energize transmitters if personnel open doors or panels accessing high field areas
- Place warning signs in any locations where high fields can occur
- Train personnel about the short-term and long-term hazards of RF radiation
- Physically block access to the area around the antenna system, feedline and tower
- Ground all exposed conductive surfaces or objects in high field areas

The RF connection to the transmitter output can be a serious safety hazard. Connect a 50 Ω test load during installation and commissioning. It is recommended that a switch be used to automatically connect the transmitter to the antenna system without human contact with the transmitting conductors.

Safety Interlocks

The transmitter contains an electrical interlock, which is an external circuit that turns off the RF output if any of its switches are opened.

Ac Disconnect Switch

Safe operation of the transmitter requires an ac disconnect switch. Lock the ac disconnect switch in the disconnected (open) position during the installation process.

Equipment Safety

Electrostatic Protection

The transmitter's systems are very rugged and resistant to damage. However, it is possible for damage to occur because of high voltage electrostatic discharges during servicing. Train all service personnel to ground themselves to bleed off any static charge before opening the transmitter or touching any exposed components. Provide a grounding wand or known ground (e.g., a grounded metal table) that personnel can use to discharge themselves.

Surge Protection

Surge protection is recommended for your entire site. However, even if you do not use a surge protector on the service entrance to the site, you should install a surge protector in the transmitter's ac power feed to prevent over-voltage from entering the transmitter.

Lightning Protection

The transmitter is designed to resist lightning strike damage. However, intense or repeated strikes could damage the transmitter. We recommend that you install lightning suppression on the antenna, tower and feedline to reduce the effect of lightning strikes on the transmitter itself (and to protect the rest of your site equipment and your personnel). For detailed information about lightning protection, see the Nautel Site Preparation Manual, available from your Nautel sales agent, or online from the Nautel website.

Physical Protection

Consider physical hazards to equipment at your site, including the transmitter. Ensure that equipment is protected from weather (e.g., rain or flooding), even during extreme weather events. Place equipment so that it is not in the path of swinging doors or high-traffic areas. Do not allow wheeled items like office chairs or tables with wheels in the transmitter room, as these may damage equipment if accidentally pushed or knocked over. Do not place the transmitter under water pipes, drains, or sprinklers. Keep any equipment that generates heat, like the transmitter, away from flammable materials like ceiling panels, cubicle dividers, and curtains.

Earthquake Protection

If the transmitter site is in a region that experiences any noticeable earthquake activity, take steps to prevent the transmitter from shifting or rocking during an earthquake. Even during minor earthquakes, rocking or movement of the transmitter is likely to damage the feedline connection, and could even cause a catastrophic failure of the ac power feed into the transmitter. During larger earthquakes, the weight of the transmitter chassis could be hazardous to nearby equipment or personnel. The NV20LT/NV15LT is equipped for floor-mounting. Refer to [Section 1.3, "Physical Requirements"](#) for more information.

FCC Supplier Declaration of Conformity



Kevin T. Rodgers
Chief Executive Officer
krodgers@nautel.com

SUPPLIER'S DECLARATION OF CONFORMITY
According to 47 CFR § 2.1077 Compliance Information

We:

Nautel Maine Inc.
201 Target Industrial Circle
Bangor, ME
04401, USA
+1 207-947-8200

declare under our sole responsibility that the product:

Product Name: NVLT Series FM Transmitter
Model Number: NV20LT

complies with parts 2 and 73 of FCC rules

Kevin Rodgers
Chief Executive Officer

Date: August 23, 2019

Nautel Inc 201 Target Industrial Circle, Bangor, ME, USA 04401
Tel: +1.207.947.8200 Fax: +1.207.947.3693 info@nautel.com
MAKING DIGITAL RADIO WORK.

Page 1 of 1



Kevin T. Rodgers
Chief Executive Officer
krodgers@nautel.com

SUPPLIER'S DECLARATION OF CONFORMITY
According to 47 CFR § 2.1077 Compliance Information

We: Nautel Maine Inc.
201 Target Industrial Circle
Bangor, ME
04401, USA
+1 207-947-8200

declare under our sole responsibility that the product:

Product Name: NVLT Series FM Transmitter
Model Number: NV15LT

complies with parts 2 and 73 of FCC rules

A handwritten signature in black ink that reads "Kevin Rodgers". The signature is written in a cursive, flowing style.

Kevin Rodgers
Chief Executive Officer

Date: August 23, 2019

Nautel Inc 201 Target Industrial Circle, Bangor, ME, USA 04401
Tel: +1.207.947.8200 Fax: +1.207.947.3693 info@nautel.com
MAKING DIGITAL RADIO WORK.

Page 1 of 1

NOTICE ACCOMPANYING SALES

For HD Radio Users Only

NOTICE ACCOMPANYING SALES

NOTIFICATION OF
RIGHTS AND LICENSE REQUIREMENT

**BROADCAST EQUIPMENT PURCHASES OR LEASES
FROM AUTHORIZED EQUIPMENT MANUFACTURERS**

The sale or lease of broadcast equipment to the Buyer does not include any patent rights to “use” the broadcast equipment or any rights to the software resident on the broadcast equipment; and no license to use broadcast equipment, to copy the software during use of the broadcast equipment or to distribute the software can be implied. Nor does Buyer receive, through the purchase or lease of broadcast equipment, whether preprogrammed or unprogrammed, the right to use or practice any patented method of iBiquity and no such right can be implied.

Using the broadcast equipment, copying the software during use, or distributing the software through resale of the broadcast equipment, whether alone or as a component of another device, without a license from iBiquity Digital Corporation or its Affiliates shall be deemed an infringement of iBiquity’s patents, trade secrets and/or copyrights. To acquire patent “use” rights in and to broadcast equipment and rights to use the software resident on such broadcast equipment, Buyer must sign a license agreement with iBiquity Digital Corporation or its Affiliates.

iBiquity Digital Corporation can be contacted for licensing information at the following address, telephone number or e-mail address:

iBiquity Digital Corporation
6711 Gateway Drive, Suite 500
Columbia, MD 21046
USA
Attention: Broadcast Licensing Department
(443) 539-4390
licensedproductnotification@xperi.com

SECTION 1.1: DESCRIPTION

This section provides a basic description of the NV20LT/NV15LT transmitter and includes the following topics:

- [Capabilities](#)
- [Standard Configuration and Options - see page 1.1.3](#)

Capabilities

Power

The NV20LT/NV15LT is a solid-state, VHF, frequency modulated broadcast transmitter that is capable of continuous RF output power up to 22 kW (NV20LT) or 16.5 kW (NV15LT) in analog mode of operation into a maximum 1.2:1 VSWR.

The operator can vary the power continuously or switch to preset power levels using the NV20LT/NV15LT advanced user interface (AUI). Presets store the power level, frequency and audio input settings.

Frequency

The transmitter is broadband and can operate at any frequency in the FM broadcast band (87.5 - 108 MHz), into a nominal 50 ohm, unbalanced transmission line. This design is ideally suited for all N+1 configurations.

Antenna Tolerance

The NV20LT/NV15LT will operate at rated power even with a VSWR of 1.5:1. A higher VSWR results in a protective foldback of output power. The greater the VSWR, the greater the reduction in RF power until shutdown occurs at 3:1 VSWR or greater.

Remote Control and Monitoring

You can monitor all key parameters of NV20LT/NV15LT operation, and control common functions, such as power output and preset settings, from a remote location.

The NV20LT/NV15LT allows for discrete remote control and monitoring wiring to terminal block connectors, using a multiconductor signaling cable from the transmitter to an optional remote control board. If the optional remote interface PWB is not purchased, remote interfacing is available on a D-sub connector on the rear of the controller module. You can also use a web browser, from any web-interfaced device, to access most of the transmitter's local functionality (excludes system parameters that must be configured locally).

Redundancy

The NV20LT/NV15LT features redundancy in several key systems:

- ❖ RF power modules and RF power amplifiers
- ❖ RF power module power supplies
- ❖ Exciters (optional)
- ❖ Low voltage power supplies (optional)
 - supply power to LVPS via external user-provided UPS (see “UPS” for details)
- ❖ Control and monitoring facilities

Ac Power

The NV20LT/NV15LT can operate from a nominal 50/60 Hz, three-phase, 208 V or 380 V ac power source or a single-phase, 240 V ac power source. Nautel pre-configures your transmitter to accommodate the required ac power source.

For detailed electrical requirements (e.g., input power, maximum line current, etc.), refer to [Table 1.5.2](#) in [Section 1.5, “Electrical Requirements”](#).

UPS

The transmitter can be factory-configured or field-configured with a UPS interface option, which - in conjunction with a user-provided UPS - enables continued operation of the control and monitoring circuitry during brief ac power losses. The assembly contains a 30 V power supply that powers the transmitter's LVPS distribution plate (ORed with the transmitter's low voltage power supplies), which power the transmitter controller (remote AUI) and control and monitoring circuitry logic during an ac brown-out period. This allows continued AUI navigation and eliminates reboot times, greatly increasing speed of recovery from an ac loss.

For UPS requirements (e.g., power capability, output voltage range, etc.), refer to [Table 1.5.2](#) in [Section 1.5, “Electrical Requirements”](#).

Standard Configuration and Options

Typically the NV20LT/NV15LT is factory shipped with a base-level, standard configuration. There are various options available, that can be factory installed prior to equipment delivery (contact your Sales representative for more details) or easily field-installed by the user.

Each of these options is provided as a kit that is packed separately, and includes its own Quick-Guide (QG) documentation to aid the user in installing and configuring the option. For some options, the field-installation instructions are also included in the NV20LT/NV15LT Installation Manual.

Exciter

The NV20LT/NV15LT is factory configured with a single exciter, which is part of a controller module (A4) that is provided with each transmitter.

You can arrange pre-delivery factory installation or you can purchase and install a Dual Exciter Upgrade Kit (Nautel Part # 219-5135-*), which includes a standby exciter (Nautel Part # NAE107*) and the instructions (Quick-Guide QG12004*) to field-install the exciter and configure the transmitter for dual exciter operation and enable the auto changeover function.

Low Voltage Power Supply

The NV20LT/NV15LT is factory configured with a single LVPS module only.

You can arrange pre-delivery factory installation or you can purchase and install an LVPS Module Kit (Nautel Part # 219-5150-**), which includes an additional LVPS module (Nautel Part # UG132) and the instructions (Quick-Guide QG12005*) to field-install the LVPS and configure the transmitter to recognize the additional LVPS module. When the additional LVPS is installed, it acts in parallel with the existing LVPS to improve the reliability of the transmitter. You can purchase up to three additional redundant LVPS modules.

Remote Control/Monitor

The NV20LT/NV15LT is factory configured with a controller module (with integrated exciter), which provides rear panel connections to allow discrete control/monitor wiring (D-sub) as well as web-based (LAN) access to the advanced user interface (AUI).

You can arrange pre-delivery factory installation or you can purchase and install a Remote Interface PWB Kit (Nautel Part # 219-5160-*), which includes the NAPI143/02 Remote Interface PWB, interconnect cabling, and the instructions (Quick-Guide QG12006*) to field-install and configure the remote interface PWB. This board contains terminal block connections for the customer's remote control and monitoring wires and external interlock. It also contains push-button switches (e.g., RF on, RF off, power increase, power decrease, reset, etc.) and status LEDs (e.g., RF on status, preset status, various alarms), which provide an additional local means to control and monitor the transmitter, particularly if the local UI fails or the remote AUI is unavailable.

Audio Processor

The NV20LT/NV15LT is factory configured with no internal audio processor cards.

You can arrange pre-delivery factory installation or you can purchase and install an internal Orban Inside Kit (Nautel Part # 206-5575-*), which contains an Orban audio processor and the instructions (Quick-Guide QG12001*) to field-install and configure the Orban card. The Orban card is installed on stand-off terminals directly above the exciter/control PWB in the controller module (with integrated exciter) and/or optional exciter module.

UPS Interface

The NV20LT/NV15LT is factory configured without a UPS interface assembly installed.

You can arrange pre-delivery factory installation or you can purchase and install a UPS interface upgrade kit (Nautel Part # 219-5140-*) that facilitates the use of an external, user-provided UPS. The kit includes a UPS interface assembly (Nautel Part # 219-5144-*) and the instructions (Quick-Guide QG12007*) to field-install the assembly near the ac input terminal block at the bottom of the transmitter cabinet.

The assembly contains two ac connectors that provide UPS power to a 30 Vdc power supply (supplied with the UPS Interface kit) which then provides power to the system logic (controller, exciter logic, and rack PWB logic) during an ac brown-out period. Fans, RF drive and the final power stage will be inhibited, but the front panel UI and remote AUI will continue to operate. This also eliminates reboot times, greatly reducing the off-air time and increasing the speed of recovery from an ac loss.

SECTION 1.2: PRE-INSTALLATION TASKS

This section provides a list of tasks that you must perform prior to delivery and installation of the NV20LT/NV15LT transmitter.

WARNING! FAILURE TO COMPLY WITH RECOMMENDATIONS MAY VOID YOUR MANUFACTURER’S WARRANTY. FOR MORE INFORMATION, REVIEW YOUR WARRANTY DOCUMENTS.

Preparing for Installation

To prepare for installation of an NV20LT/NV15LT transmitter, perform the following tasks:

NOTE: Refer to [Figure 1.2.2 on page 1.2.5](#) for quick reference pre-installation information for the NV20LT/NV15LT.

1. Verify that your ac power source matches the transmitter configuration. The transmitter is factory configured for the ac power source specified in contract documents. Power source options include 208 V ac (175 - 265 V ac line-to-line), three-phase (three-wire plus ground) OR 380 V ac (303 - 459 V line-to-neutral), three-phase (four-wire plus ground), OR 240 V ac (175 - 265 V line-to-neutral) single-phase (two-wire plus ground). If your ac power source is different than the factory configuration (See [Figure 1.2.1](#) for example), contact Nautel to arrange reconfiguration.

Figure 1.2.1: Factory Configuration Sheet

Factory Transmitter Configuration			
The transmitter has been factory configured as follows (see manual for more information):			
Sales Order: _____		Transmitter Serial Number: _____	
AC Input	AC Configured	By:	
	AC Configuration:	208 Vac nom., 3-Ph <small>(175-265 Vac L-L)</small>	<input type="checkbox"/>
	380 Vac nom., 3-Ph <small>(175-265 Vac L-N) (303-459 Vac L-L)</small>	<input type="checkbox"/>	
	240 Vac nom., 1-Ph <small>(175-265 Vac L-L, L-N)</small>	<input type="checkbox"/>	
	AC Configuration Verified	By:	Date:
RF Output	7/8 inch EIA	<input type="checkbox"/>	
	1-5/8 inch EIA	<input type="checkbox"/>	
	3-1/8 inch EIA	<input type="checkbox"/>	
	4-1/16 inch	<input type="checkbox"/>	
Dual Exciter Installed	Yes <input type="checkbox"/>	No <input type="checkbox"/> <small>The customer is responsible to supply audio to both exciters.</small>	
Redundant LVPS Kit Installed	Yes <input type="checkbox"/>	No <input type="checkbox"/> <small>No customer action required.</small>	
Remote Interface Kit Installed	Yes <input type="checkbox"/>	No <input type="checkbox"/> <small>The customer is responsible to supply remote control/monitor wiring.</small>	
UPS Interface Kit Installed	Yes <input type="checkbox"/>	No <input type="checkbox"/> <small>The customer is responsible to supply the external UPS and wiring. The external UPS is not required for transmitter operation.</small>	
Audio Processor Installed	Yes <input type="checkbox"/>	No <input type="checkbox"/> <small>The customer is responsible to configure the audio processor settings.</small>	

Factory Transmitter Configuration
215-0115 Rev. -
July 30, 2015

NOTE: The NV20LT/NV15LT's full ac input voltage range is 90 - 265 V ac, but RF output power is limited to approximately 33% of rated power when the ac input voltage is less than 175 V ac.

2. Select a location for the transmitter in the transmitter room. See [Figure 1.2.2 on page 1.2.5](#) for transmitter dimensions and required clearances. Determine whether additional heating, ventilating or cooling capacity is needed at the site. Identify any special requirements regarding air flow around the cabinet (for example, ducting hot air away from the cabinet, or bringing in external cooling air). Contact Nautel for closed ventilation or semi-closed ventilation configurations to ensure the transmitter is factory configured to address your cooling needs. Identify a suitable work space near the transmitter to allow for maintenance.
3. The transmitter is factory configured to accept ac input wiring at the top of the cabinet for typical installations. Contact Nautel to discuss your bottom ac entrance requirements if applicable, to ensure the transmitter is factory prepared to facilitate a simplified connection.
4. If you are purchasing the UPS interface option, you will need to route additional ac wiring to the transmitter cabinet from the external UPS. Consider the ac input wiring entry method in [Step 3](#) and note that you can route UPS wiring through the top of the transmitter cabinet (pilot hole provided; see [Figure 1.3.1 on page 1.3.2](#)) or through the bottom of the cabinet.
5. If you are planning to anchor your transmitter against seismic activity, prepare the transmitter room floor to accept four anchoring bolts. Four 5/8-inch (16 mm) holes are provided in the transmitter floor to allow this (see [Figure 1.2.2 on page 1.2.5](#) for hole location). Square washers are provided in the ancillary kit to aid in anchoring the transmitter (see NV20LT/NV15LT Installation Manual).
6. If this is an upgrade or replacement transmitter (that is, if the site is already set up for a transmitter), proceed to [Step 10](#). If you are upgrading a site, verify the feedline, the lightning protection systems, and the ac power service.

NOTE: Be aware of lightning protection issues when installing ac power and RF feedline. Lightning protection is essential to protect both personnel and equipment at your site. Refer to the Lightning Protection section of Nautel's Recommendations for Transmitter Site Preparation Manual.

7. Install ac power service into the planned transmitter location, and select a location near the transmitter for the ac disconnect switch (available from Nautel). Consult with an electrician prior to receiving the transmitter regarding local electrical codes and special considerations based on transmitter power consumption, and wire routing (top or bottom entry, see [Step 3](#)). For quick reference to ac power requirements, see [Figure 1.2.2 on page 1.2.5](#). For detailed information, see "[Main Electrical Power](#)" on page 1.5.1.
8. Install lightning protection on the antenna tower. Refer to the Recommendations for Transmitter Site Preparation Manual, provided with the transmitter.

-
9. Place a work area with a clear table surface near the transmitter. Provide electrostatic protection measures in the work area.
 10. Order any accessories or optional equipment that you may need. Typical requirements include:
 - ❖ Tools - soldering iron, screwdrivers, wrenches, torque wrenches, etc. (see [Section 1.9, "Parts and Tools"](#) on [page 1.9.1](#) for further details).
 - ❖ Test equipment - oscilloscope and digital multimeter.
 - ❖ Peripheral equipment - PC or laptop, LAN/network connection, etc.
 - ❖ If you are using a network connection (as opposed to a direct connection with a laptop), consult with your network administrator to determine whether the NV20LT/NV15LT's network feature will be enabled. If so, determine whether DHCP will be used. DHCP allows network IP addresses to be assigned automatically. To use DHCP, you must have a visible DHCP server on your network. If you are not planning to use DHCP (i.e., your network does not have a DHCP server or you are connecting directly to a laptop), you must obtain an IP address and netmask from your network administrator as well as gateway and nameserver(s) as applicable. If more than one transmitter exists on the LAN, consider port forwarding when commissioning the transmitter.
 11. Terminate the transmitter end of the RF feedline with a connector. NOTE: Nautel pre-configures your transmitter with the connector specified in contract documents. If your RF feedline connector is different than the transmitter's connector, contact Nautel to arrange reconfiguration.
 12. Arrange manpower or lifting equipment to move and assemble the transmitter. You will most likely need a forklift or mechanical assistance to move the transmitter into place for installation.
 13. Implement a safety interlock, if required.
 14. Prepare to integrate the NV20LT/NV15LT transmitter into your station control circuitry, if required.
 15. Train your station technicians and operators on the use and maintenance of the NV20LT/NV15LT transmitter.

Selecting a Location for the Transmitter

To ensure that the desired location for the NV20LT/NV15LT transmitter is suitable, perform the following tasks:

1. Ensure that the floor area where the transmitter will be located is able to support the weight of the transmitter system. For quick reference to transmitter weights, see [Figure 1.2.2 on page 1.2.5](#). For detailed information, see ["Physical Requirements" on page 1.3.1](#).
2. Measure the space to ensure that the transmitter will fit. For quick reference to transmitter dimensions and clearances, see [Figure 1.2.2 on page 1.2.5](#), or see [Section 1.3, "Physical Requirements"](#).
3. Ensure that transmitter room doors and the pathway of access from the receiving dock or building exterior to the installation location are large enough to accommodate the transmitter.

Installing an Antenna Feedline

When installing an antenna feedline for the NV20LT/NV15LT transmitter, perform the following tasks:

1. Ensure that the RF feedline that will connect the transmitter and the antenna system is suitably rated.
2. Connect the shield of the antenna feedline directly to the station reference ground where it enters the building. For more information about the station reference ground, see ["Station Reference Ground" on page 1.5.6](#).
3. Install lightning protection devices. For more information about lightning protection, refer to the Lightning Protection section of Nautel's Recommendations for Transmitter Site Preparation Manual.
4. Pass the center conductor and the shield of the feedline cable through a minimum of two ferrite toroids, if possible, that are positioned between the shield ground at the building entrance and the shield termination at the transmitter. Install the ferrite toroids prior to installing user-provided flanges on the feedline cable. The transmitter's ancillary kit includes suitable ferrite toroids for this purpose.

Figure 1.2.2: NV20LT/NV15LT Pre-installation Guide

REQUIRED CLEARANCES

Front: 1.2 m (4 ft)
 Rear: 0.9 m (3 ft)
 Sides: 0 m (0 ft)
 Top: 1.2 m (4 ft)

WEIGHT

Uncrated: 376 kg (830 lbs)
 Crated: 472 kg (1040 lbs)

COOLING

Maximum Intake Air Temperature (varies with site altitude as follows):

50°C (122°F) at sea level
 47°C (116.6°F) at 500 m (1640 ft)
 44°C (111.2°F) at 1000 m (3281 ft)
 40.4°C (104.7°F) at 1600 m (1 mile or 5280 ft)
 30°C (86°F) at 3048 m (10,000 ft)

Air Conditioning Requirements in Closed Room Cooling (based on maximum output power and typical efficiency):

FM mode: 2.44 (NV20LT) or 1.92 (NV15LT) tonnes

Forced air cooling systems require a minimum of 1700 CFM. The static pressure at the exhaust duct must be slightly negative. The static pressure at the intake duct must be neutral or slightly positive.

HEATING

Minimum transmitter room ambient air temperature is 0°C (32°F)

AC INPUT WIRE LIMITATIONS & TORQUE REQUIREMENTS

WIRE SIZE RANGE: 300 MCM to 4 AWG (150 to 12 mm²)
 TB1 TORQUE VALUE: 275 in-lbs (31.1 N-m) for each of two inputs

AC INPUT SPECIFICATIONS

MODE OF OPERATION	INPUT POWER (kVA)	AC SUPPLY (V ac)	TYPICAL LINE CURRENT (A)
FM (analog)	31.2 (NV20LT) 23.7 (NV15LT)	3-Ph, 208 V ac (**175-265)	86 (NV20LT), 66 (NV15LT)
		3-Ph, 380 V ac (**303-459)	48 (NV20LT), 36 (NV15LT)
		1-Ph, 240 V ac (**175-265)	130 (NV20LT), 100 (NV15LT)

** Denotes that the transmitter will operate with an ac input voltage as low as 90 V ac (for 208 and 240 V sources; 156 V ac for 380 V sources), but RF output power is limited (to approximately 1/3 of rated power) at ac voltages less than 175 V ac (for 208 and 240 V sources; 303 V ac for 380 V sources).

Typical line current values are based on maximum RF output power, nominal ac voltage (208 or 380 V ac 3-phase, or 240 V ac 1-phase, as applicable), typical efficiency and 0.98 power factor.

The maximum inrush current value (per line) is present for half an ac cycle (between 8 and 10 ms) and is based on an ac input voltage of 230 V ac. The maximum inrush current per line is approximately 210 A for three-phase ac power sources and 600 A for single-phase ac power sources.

Observe local electrical codes when determining wire size and circuit breakers. Nautel recommends that you base your wire sizes and breaker ratings on the typical line current for analog mode plus 25% to account for line current imbalance and site mains regulation.

TB1: Ac Terminal Block
 (below ac entrance box; see Installation Manual)

CABLE TOP ENTRY NOTE:

Exciter wiring, top ac wiring and remote access holes have removable plates with pre-cut 1/4-inch dia holes. Use a chassis punch tool (e.g., Greenlee) to create the desired hole size (up to 2 inches) on the plate. Remove the plate to access a larger hole, if necessary.

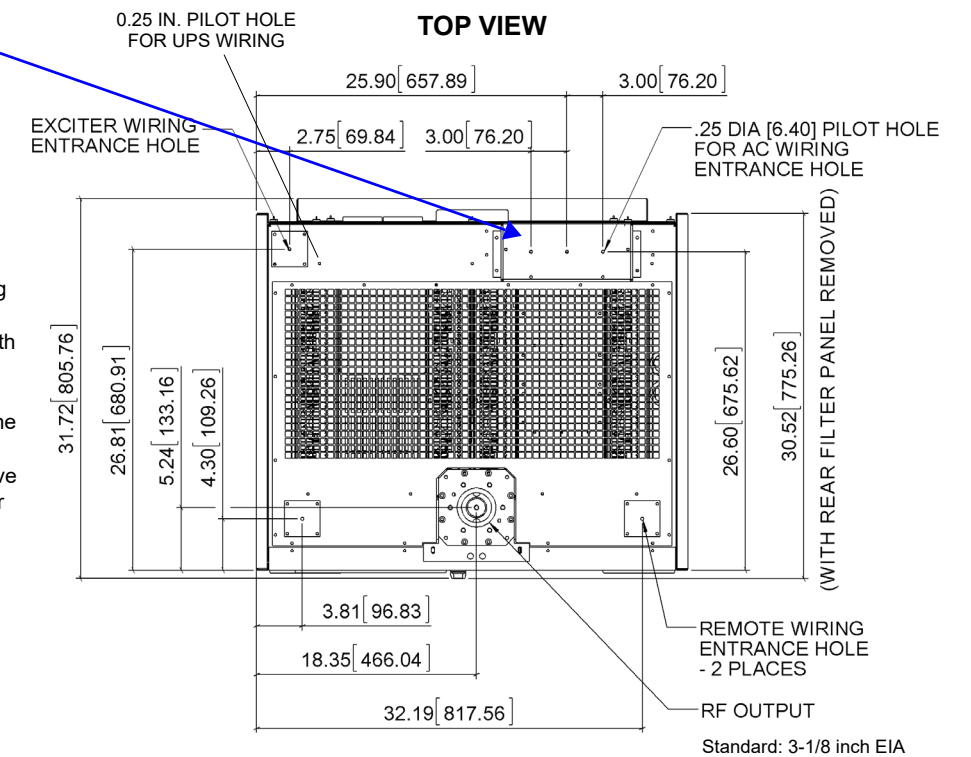

AIR FILTERS (front and rear)
 Nautel Part # HR195
 15" x 24" x 2"
 Actual dimensions: 14.5" x 23.5" x 1.75"
 American Air Filter Perfect-Pleat HC M8 MERV 8 or equivalent

* Consult Nautel to discuss bottom ac entrance configuration options

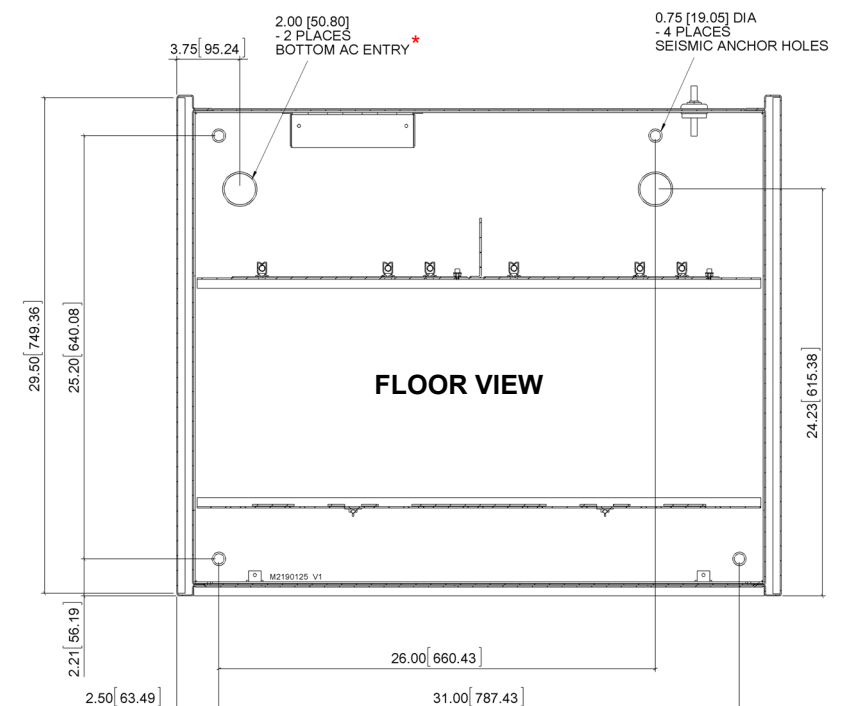
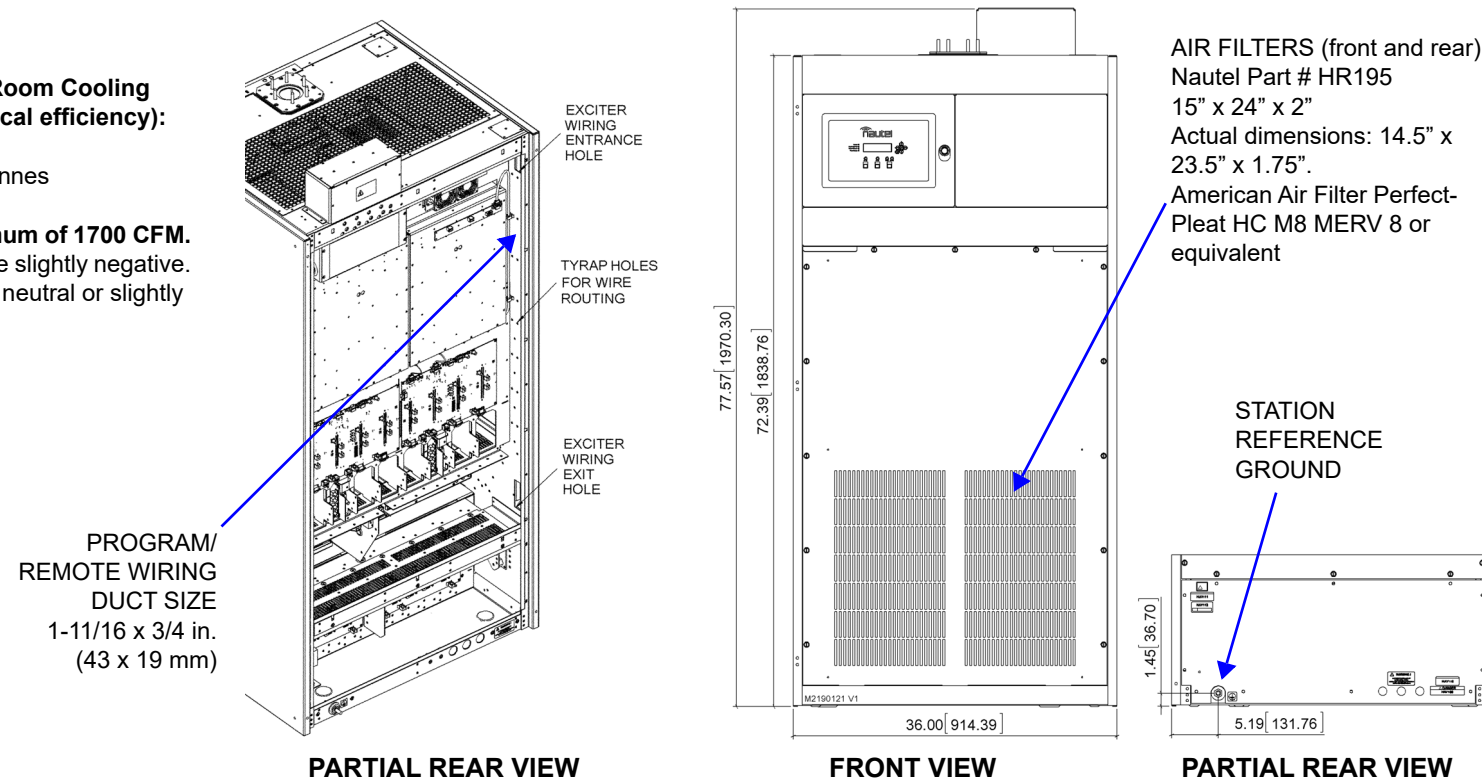

SECTION 1.3: PHYSICAL REQUIREMENTS

This section provides physical specifications for the NV20LT/NV15LT transmitter and its components, and lists physical site requirements. This section includes the following topics:

- [Dimensions](#)
 - ❖ [NV20LT/NV15LT Top View - see page 1.3.2](#)
 - ❖ [NV20LT/NV15LT Front and Top Views - Exhaust Dimensions - see page 1.3.3](#)
 - ❖ [NV20LT/NV15LT Front View and Partial Rear View - see page 1.3.4](#)
 - ❖ [NV20LT/NV15LT Floor View \(Seismic Anchoring and Ac Entry Hole Dimensions\) - see page 1.3.5](#)
- [Clearances - see page 1.3.6](#)
- [Weight - see page 1.3.6](#)

Dimensions

The NV20LT/NV15LT transmitter has the following overall dimensions. See [Figure 1.3.1](#) through [Figure 1.3.4](#) for detailed dimensional views.

- Height: 184.2 cm (72.5 in)
- Width: 91.4 cm (36.0 in)
- Depth: 81.3 cm (32.0 in), including rear filter panel
76.2 cm (30.0 in.), with rear filter panel removed

Figure 1.3.1: NV20LT/NV15LT Top View

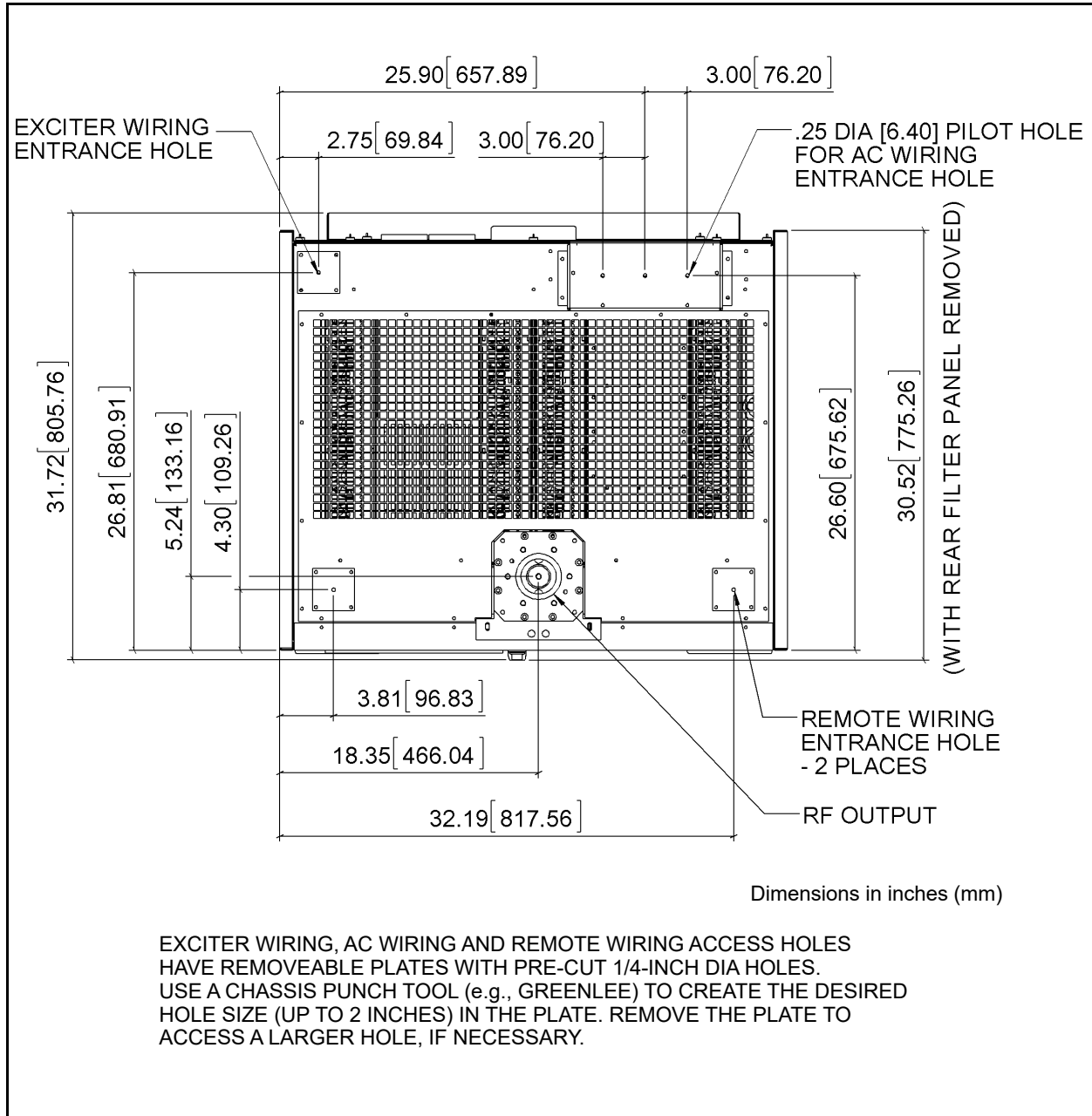

Figure 1.3.2: NV20LT/NV15LT Front and Top Views - Exhaust Dimensions

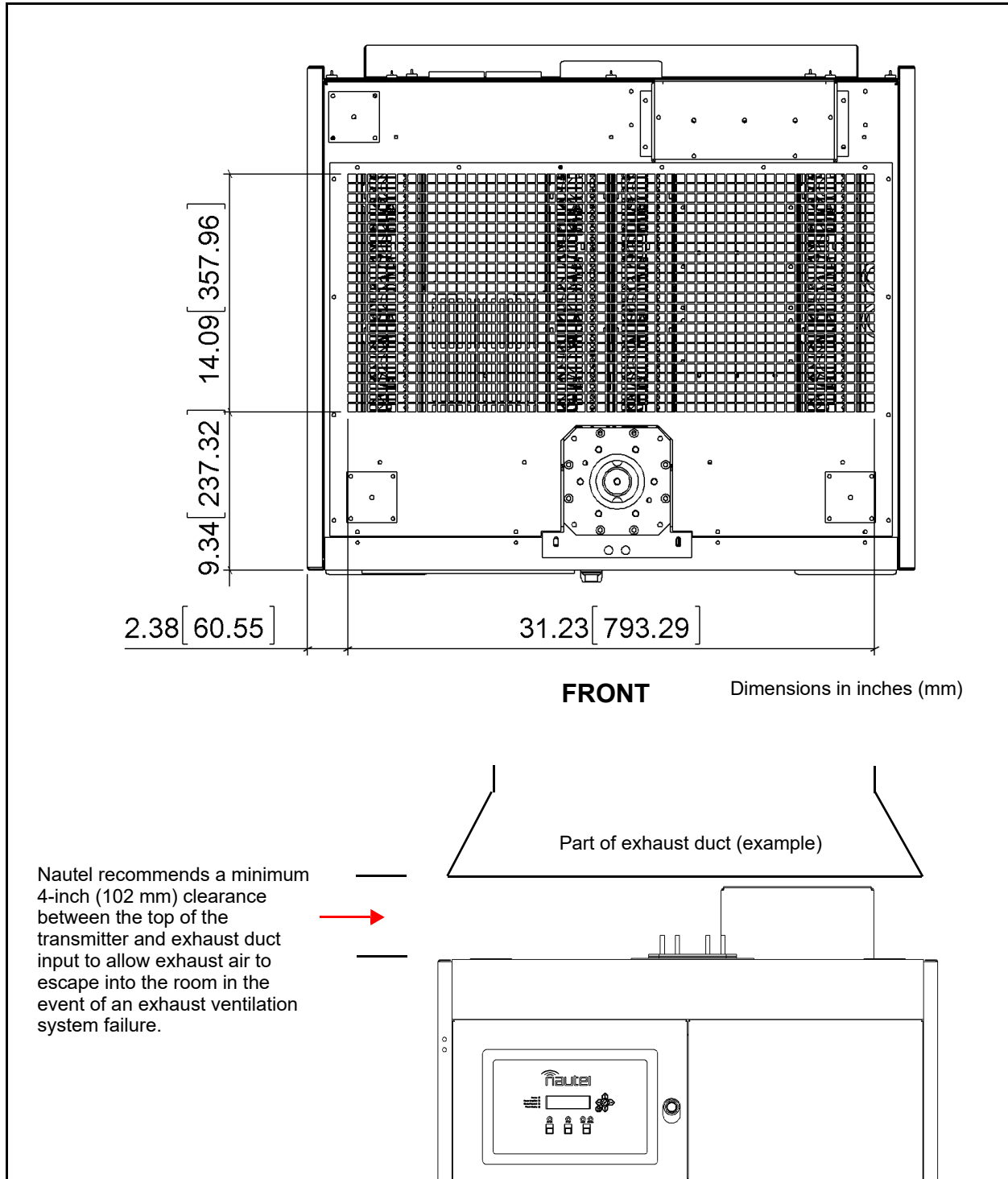

Figure 1.3.3: NV20LT/NV15LT Front View and Partial Rear View

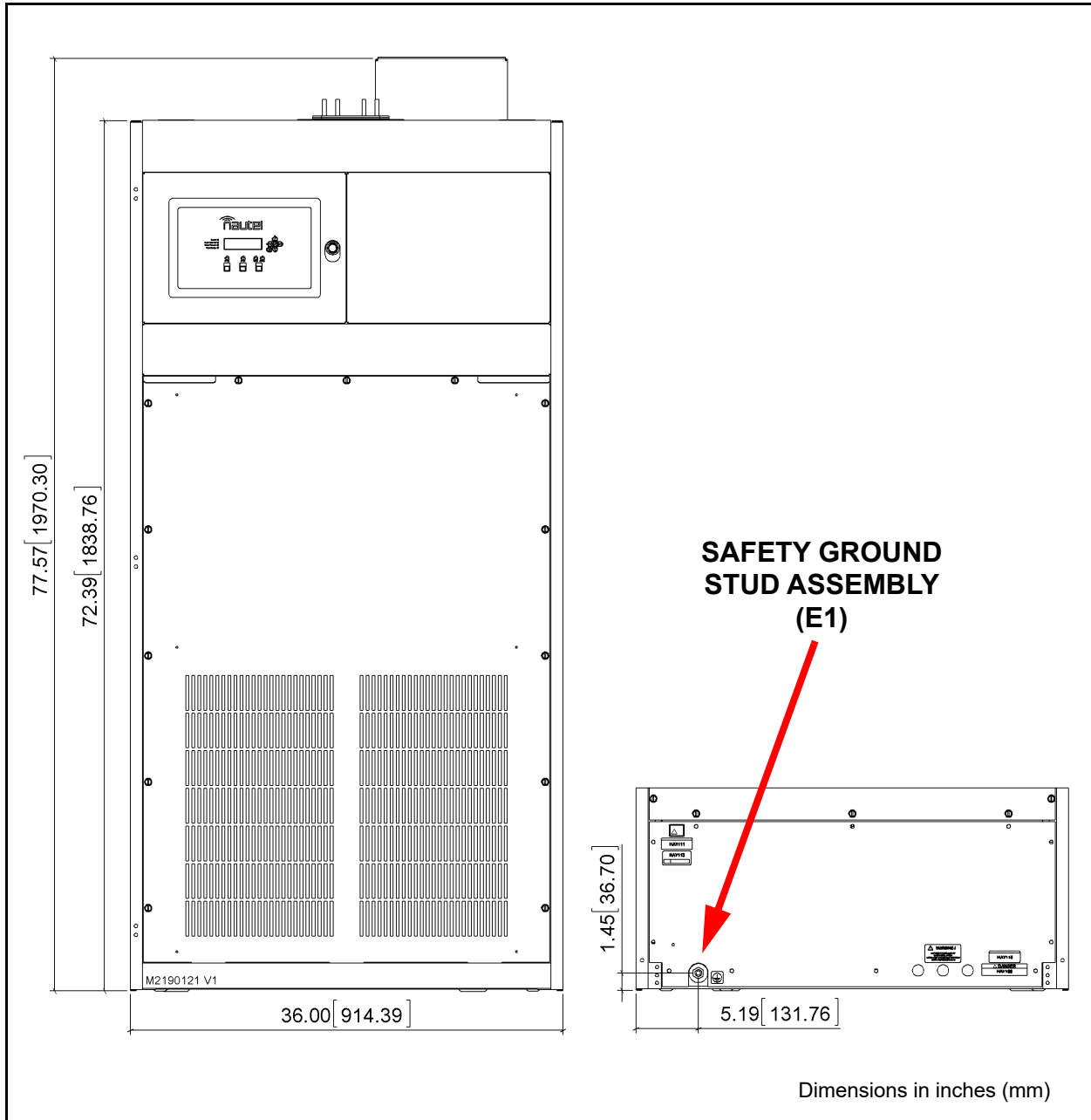
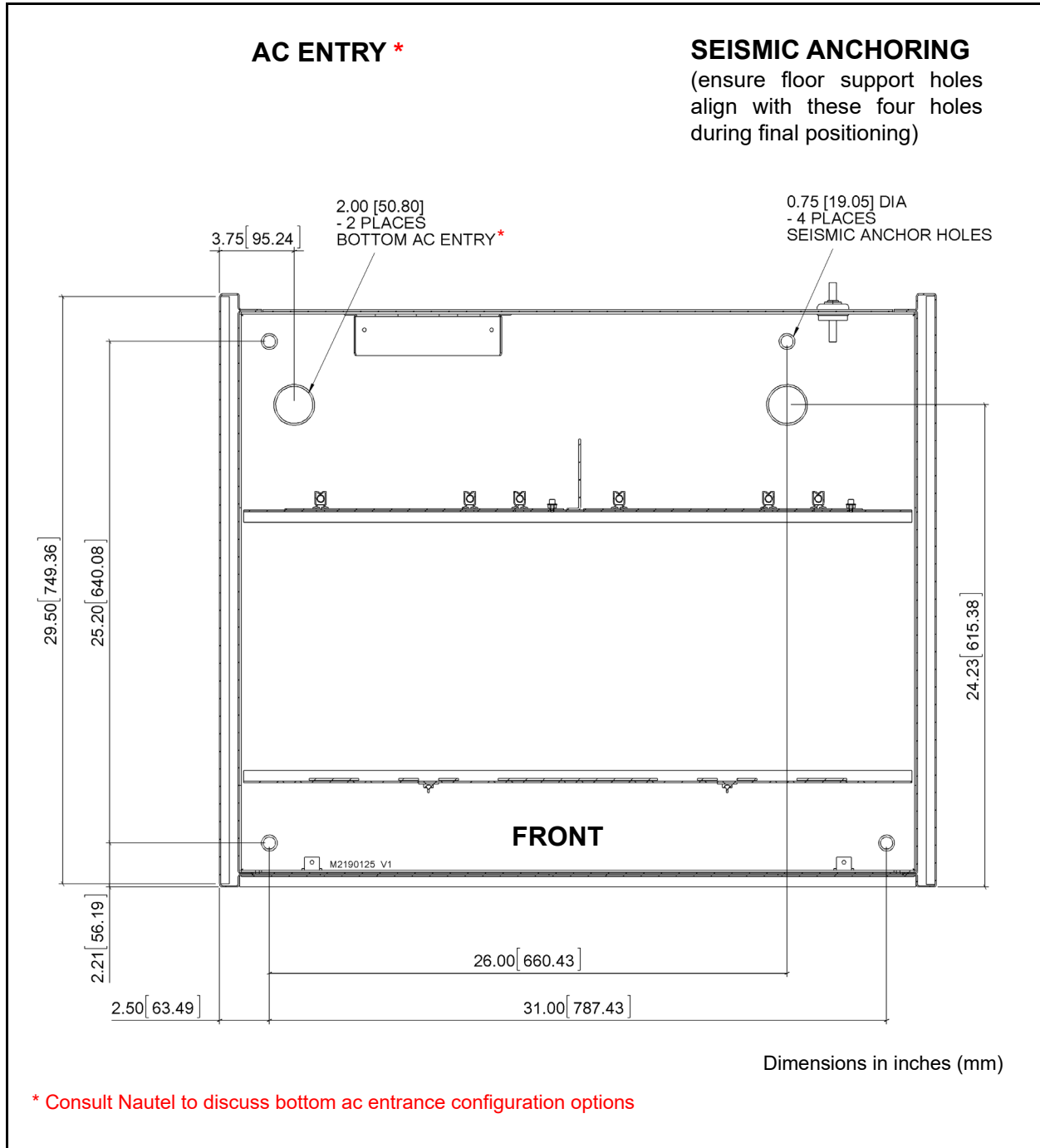

Figure 1.3.4: NV20LT/NV15LT Floor View (Seismic Anchoring and Ac Entry Hole Dimensions)



Clearances

For the transmitter cabinet, the required minimum clearances are 1.2 m (4.0 feet) at the front to allow for comfortable access to the front panel UI, 1.2 m (4.0 feet) at the top to allow for cable and ducting, and 0.9 m (3.0 feet) at the rear to allow for initial installation and scheduled maintenance.

Also consider access to the rear of the transmitter during servicing, and access to the front of the transmitter during replacement of RF power modules, power supply modules, controller and exciter modules, if applicable. You must allow space to remove the front panel and slide out any of the modules. These modules slide straight in and out at the front of the transmitter.

Internal fans pull cooling air through air filters in the front and back of the transmitter. The cooling air exhausts through a grill on top of the transmitter. Ensure recommended clearances are maintained to prevent restriction of air flow.

Weight

See [Table 1.3.1](#) for transmitter weights, including crated and uncrated weights.

Table 1.3.1: Weight of Components

ITEM	UNCRATED WEIGHT	CRATED WEIGHT
Transmitter (standard configuration, with modules)	376 kg (830 lbs)	472 kg (1040 lbs)
RF Power Module	14.5 kg (32 lbs)	-
Power Supply Module	2.3 kg (5 lbs)	-
Controller	5.5 kg (12 lbs)	-
Exciter (optional)	5.5 kg (12 lbs)	-

If installing the transmitter on a raised platform, the weight support distribution should be placed near the corner posts of the transmitter rack.

SECTION 1.4: COOLING REQUIREMENTS

This section provides information about heating and cooling requirements for the NV20LT/NV15LT transmitter site. Topics in this section include:

- Air Flow in the Transmitter
- Cooling - see page 1.4.2
- Heating - see page 1.4.2

Air Flow in the Transmitter

For open ventilation systems (see Figure 1.4.1), which is the default method of cooling, the transmitter accepts intake air from the room and exhausts it into the room. For the NV20LT/NV15LT, intake air is drawn in through air filters in the front and back of the transmitter. Module integrated fans circulate air through the RF power modules, controller, exciter (if used), reject load assembly, and power supplies, and then is exhausted up through the combiner/LPF section. Warm air exits the transmitter through the grill at the top.

Figure 1.4.1: Air flow in the NV20LT/NV15LT transmitter

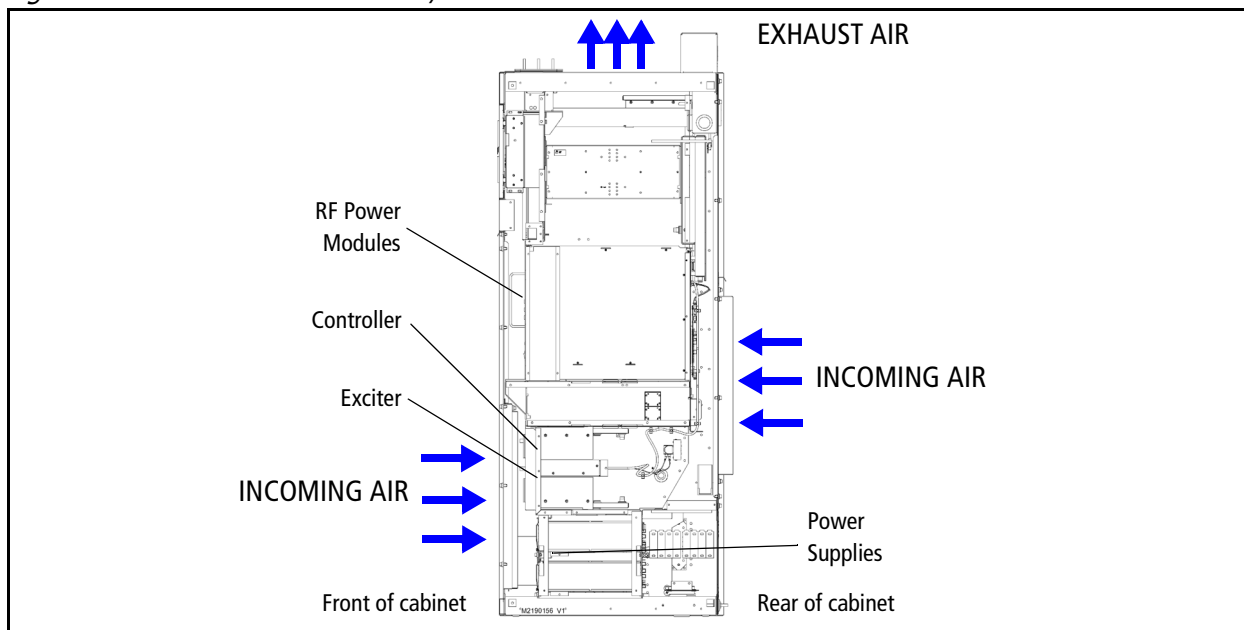

For closed ventilation systems, the air in the room does not exchange with outdoor air. Any heat generated in the room must be cooled using air conditioning. One (1) ton of air conditioning is required for 12,000 BTUs (3,514 W) of waste heat. Contact Nautel for more information.

Cooling

Do not allow the transmitter room ambient air temperature to exceed 50°C (122°F) at sea level. Cooler temperatures are recommended in order to improve the reliability of the transmitter. The transmitter contains protection circuits that monitor the intake temperature and may inhibit or reduce the RF output power if the temperature exceeds the acceptable limit. At higher altitudes, derate the maximum intake air temperature as follows:

- De-rate the ambient temperature 3°C (5.4°F) per 500 m – or 2°C (3.6°F) per 1,000 feet – above sea level.

Example:At 1600 m (1 mile or 5280 ft) above sea level, maximum ambient temperature should not exceed 40.4°C (104.7°F).

Ensure that hot, exhaust air from the transmitter is not drawn back into the transmitter’s cool air intake.

Cooling Plant Requirements

Table 1.4.1: Cooling Plant Requirements for the NV20LT/NV15LT

MODE OF OPERATION	OUTPUT POWER (WATTS)	TYPICAL EFFICIENCY (%)	WASTE HEAT (WATTS)	BTU/HOUR (X1000 BTU)	TYPICAL AIR CONDITIONING REQUIRED IN CLOSED ROOM COOLING (TONNES)
FM	22,000 (NV20LT)	72 (NV20LT)	8,556 (NV20LT)	29.200 (NV20LT)	2.44 (NV20LT)
	16,500 (NV15LT)	71 (NV15LT)	6,740 (NV15LT)	23.001 (NV15LT)	1.92 (NV15LT)

Calculating BTU Cooling Requirements

To determine the number of British thermal units (Btu) being generated per hour as waste heat, multiply the waste heat (in watts), derived from the transmitter output power and its typical efficiency, by 3.413.

Closed Loop or Forced Air Cooling Systems

Closed loop or forced air cooling systems can be used, if the air is well filtered to prevent dust and insects from entering the transmitter, and if the air system maintains a minimum air flow of 1700 cubic feet per minute (CFM). The static pressure in the exhaust duct must be slightly negative. The static pressure in the intake duct must be neutral or slightly positive.

Heating

The transmitter room must contain a heating system that will ensure the ambient air temperature does not drop below 0°C (32°F).

SECTION 1.5: ELECTRICAL REQUIREMENTS

This section describes electrical power and electrical protection requirements associated with the NV20LT/NV15LT transmitter. This section includes the following topics:

- [Main Electrical Power](#)
- [UPS Backup - see page 1.5.4](#)
- [Station Reference Ground - see page 1.5.5](#)

CAUTION! Technical pre-commissioning activities described in this section require technical decisions and the customization of electrical circuits. Do not attempt to perform these activities unless you are a certified electrician.

Refer to Nautel's Recommendations for Transmitter Site Preparation for information about requirements associated with lightning protection.

Main Electrical Power

The NV20LT/NV15LT can operate from a 50/60 Hz, three-phase or single-phase ac power source. It is factory configured to operate from the user-specified ac power source. Options include:

- ❖ 208 V ac (175** to 265 V ac) three-phase, line-to-line (three-wire plus ground)
- ❖ 380 V ac (303** to 459 V ac) three-phase, line-to-line (four-wire plus ground)
- ❖ 240 V ac (175** to 265 V ac) single-phase, line-to-neutral (two-wire plus ground)

NOTE: ** - The NV20LT/NV15LT's full ac input voltage range is 90 - 265 V ac (for 208/240 V sources; 156 - 459 V ac for 380 V sources), but RF output power is limited when the ac input voltage is less than 175 V ac (for 208/240 V sources; 303 V ac for 380 V sources).

CAUTION! Do not connect the transmitter to a 3-phase open-delta source configuration. Open delta sources cause peak voltages to be higher than expected, are more susceptible to transients and their behaviour may be unpredictable.

Connecting the transmitter to an open-delta source configuration may void the transmitter's warranty.

Voltage Stability

The ac power source nominal voltage must be stable to within rated limits (see [Table 1.5.1](#)) under all loading conditions. The transmitter contains circuitry that maintains the RF output at the preset power level for ac voltage variations within the specified range. If the ac voltage is below the specified range, but still between 90 and 175 V ac (for 208/240 V sources; between 156 and 303 V ac for 380 V sources), the transmitter can maintain operation with a reduced power limit.

Power Consumption and Typical Line Currents

Use [Table 1.5.1](#) to determine the input power requirements and typical line current expectations for a given ac supply configuration. Nautel recommends the ac power source have a 25% over-capacity to ensure adequate regulation and to account for line current imbalance.

Table 1.5.1: NV20LT/NV15LT Input Power Requirements

MODE OF OPERATION	INPUT POWER (kVA)	AC SUPPLY (V ac)	TYPICAL LINE CURRENT (A)
FM (analog)	31.2 (NV20LT) 23.7 (NV15LT)	3-Ph, 208 V ac (**175-265)	86 (NV20LT), 66 (NV15LT)
		3-Ph, 380 V ac (**303-459)	48 (NV20LT), 36 (NV15LT)
		1-Ph, 240 V ac (**175-265)	130 (NV20LT), 100 (NV15LT)

** Denotes that the transmitter will operate with an ac input voltage as low as 90 V ac (for 208 and 240 V sources; 156 V ac for 380 V sources), but RF output power is limited (to approximately 1/3 of rated power) at ac voltages less than 175 V ac (for 208 and 240 V sources; 303 V ac for 380 V sources).

Typical line current values are based on maximum RF output power, nominal ac voltage (208 or 380 V ac 3-phase, or 240 V ac 1-phase, as applicable), typical efficiency and 0.98 power factor.

The maximum inrush current value (per line) is present for half an ac cycle (between 8 and 10 ms) and is based on an ac input voltage of 230 V ac. The maximum inrush current per line is approximately 210 A for three-phase ac power sources and 600 A for single-phase ac power sources.

Observe local electrical codes when determining wire size and circuit breakers. Nautel recommends that you base your wire sizes and breaker ratings on the typical line current for analog mode plus 25% to account for line current imbalance and site mains regulation.

Ac Power Switch

Install an external ac power disconnect between the ac power source and the transmitter. Nautel can provide a suitable ac power disconnect, if required. For safety, place the ac disconnect close to the transmitter and label it TRANSMITTER EMERGENCY ON/OFF SWITCH.

Ac Transient Power Protection

Protect all conductors from the ac power source by connecting bi-directional surge protection devices between each conductor and the station reference ground. In addition, pass all the conductors and ground, as a group, through a ferrite toroid. NV20LT/NV15LT transmitters have built-in ferrite toroids for this purpose, located near the ac input terminal block. If your transmitter does not have built-in ferrite toroids, you can locate suitable ferrite toroids in the transmitter's ancillary kit.

A surge protector panel containing suitably rated varistors is available from Nautel. Install the surge protector panel close to the station reference ground, and as close as possible to the ac service entrance.

The ac power source usually has the lowest impedance path to ground during a lightning strike and normally carries most of the lightning-induced current away from the transmitter site. When lightning hits the power source (for example, striking a transmission line near the transmitter site), a significant induced current may flow towards the transmitter. The goal of lightning protection is to route the current around the transmitter to the best available ground.

For detailed information about surge protectors and lightning protection, refer to the Lightning Protection section of Nautel's Recommendations for Transmitter Site Preparation Manual.

CAUTION! Do not connect the transmitter to a 3-phase open-delta source configuration. Open delta sources cause peak voltages to be higher than expected, are more susceptible to transients and their behaviour may be unpredictable.

Connecting the transmitter to an open-delta source configuration may void the transmitter's warranty.

UPS Backup

The transmitter can operate with a UPS backup. If this option is purchased, a UPS interface assembly is factory-installed near the ac input terminal block at the bottom of the transmitter cabinet. The assembly contains one ac connector that provides UPS power to a 30 V dc power supply (supplied with the UPS Interface kit) which then provides power to the system logic (controller, exciter logic, and rack PWB logic). Fans, RF drive and the final power stage will be inhibited, but the front panel UI and remote AUI will continue to operate. This also eliminates reboot times, greatly reducing the off-air time and increasing the speed of recovery from an ac loss.

If your transmitter is already on site and you want to add the UPS backup feature, you can purchase a UPS backup kit from Nautel. The kit includes the parts and instructions required for an appropriately trained person to configure your transmitter for UPS backup operation.

The UPS must be provided by the user and meet the following specifications:

Output Voltage

Nautel requires that your UPS be capable of providing output voltage between 88 V ac and 264 V ac, single phase. This will accommodate the input of the 30 V dc power supply.

The UPS must be rated for a minimum of 150 W / 170 VA. Nautel also recommends the UPS has short circuit protection and that you install two ferrite toroids on the UPS output wiring entering the transmitter cabinet.

Interconnecting Cables

The UPS interface assembly contains an IEC 60320 C20 ac input connector. The user must provide an external, suitably rated electrical cable that is of sufficient length to connect between the user-provided UPS and the bottom, rear of the transmitter cabinet, where the UPS Interface assembly will be situated.

The cable can enter the transmitter cabinet at the top, through a user-punched hole (a 1/4-inch pilot hole is provided), or at the bottom, through a 2-inch hole that may also be used for main ac cable (consult with Nautel to discuss main ac bottom entry requirements).

Nautel provides one 20 A/250 V ac IEC straight-blade connector (Nautel Part # JD43) suitable for terminating on the end of the electrical cable. This connector mates with the UPS interface assembly's connector.

The user must also provide external conduit, as desired.

Station Reference Ground

Install a station reference ground that provides a continuous, low impedance path to the earth.

If a surge protector is not being used, connect the transmitter cabinet's safety ground stud, the RF feedline's shield, and the power source's ground connection directly to the station reference ground using a copper strap that is at least 10 cm (4 in.) wide. Ensure that the site's ac service entrance ground is directly connected to the station reference ground outside the transmitter building.

If a Nautel surge protector is being used, connect each of the transmitter cabinet's safety ground stud, the RF feedline's shield, the power source's ground connection, and the surge protector's ground stud to the station reference ground using a copper strap that is at least 10 cm (4 inches) wide.

The station reference ground should be located in close proximity to the building's ac power and RF feedline entrance points.

Ensure that the transmitter site's grounding rods are adequate. For more information about electrical grounding protection, see Nautel's Recommendations for Transmitter Site Preparation manual.

SECTION 1.6: RF OUTPUT REQUIREMENTS

This section describes requirements associated with the antenna and RF cabling to be used with the NV20LT/NV15LT transmitter. Antenna considerations include the following:

- [Antenna Feed Cable](#)
- [Antenna System](#)

For detailed information about protecting the antenna system from lightning strikes, see Nautel's Recommendations for Transmitter Site Preparation Manual.

Antenna Feed Cable

The antenna feed cable interconnecting the transmitter and the antenna system should be a suitably rated coaxial cable. The RF output is factory configured to accept a non-gas type 3-1/8 inch EIA flange (male) connection (appropriate field flange and male inner connector is not provided with the transmitter).

NOTE: The RF output connector is factory configured prior to shipping.

NOTE! Nautel does not typically supply bullets as there is no guarantee that they will be compatible with all potential hardline used at the transmitter site. It is recommended that the customer supply this part and ensure a snug fit exists between the transmitter RF output cup and EIA flange connector.

Antenna System

Ideally, the antenna system should present $50 \pm j0$ ohms impedance at the carrier frequency and have sufficient bandwidth to allow transmission of the modulated carrier. The transmitter will function at rated power while operating into a maximum VSWR of 1.5:1, after which the transmitter begins to fold back the RF output (up to a VSWR of 3:1). Circuitry within the transmitter will prevent damage to the transmitter from high VSWR loads.

SECTION 1.7: PLANNING PROGRAM INPUTS

The NV20LT/NV15LT accepts a variety of analog and digital program inputs. This section describes the requirements associated with the audio feeds to the transmitter. All connections are made at the back of the controller (with integrated exciter) (see [Figure 1.7.1 on page 1.7.7](#)) and optional exciter (see [Figure 1.7.2 on page 1.7.8](#)), depending on exciter configuration.

Where D-sub connectors are used as the interface, Nautel provides associated mating connectors in the ancillary parts kit to facilitate customer connections. Optional audio breakout cable assemblies are also available. See [Figure 1.7.3 on page 1.7.9](#) for details on possible cable configuration based on desired interfacing to the exciter module.

- Analog Inputs
 - ❖ Left and Right Inputs - see page 1.7.2
 - ❖ SCA Generator Input - see page 1.7.2
 - ❖ MPX Input - see page 1.7.3
 - ❖ MPX SCA Inputs - see page 1.7.4
- Digital Inputs - see page 1.7.4
 - ❖ AES/EBU Input - see page 1.7.4
 - ❖ RBDS/RDS Input - see page 1.7.5
- Other Features - see page 1.7.5
 - ❖ Carrier Frequency and Pilot Phase Control (10 MHz and 1 PPS IN) - see page 1.7.5
 - ❖ Pilot/MPX Sample - see page 1.7.6

NOTE:

If you are not purchasing the optional exciter (A5, NAE107*), plan to connect your program inputs to the controller (A4, NAE106*).

If you are purchasing the optional exciter, plan to connect your program inputs to both the controller (A4) and the standby exciter (A5).

Analog Inputs

The NV20LT/NV15LT accepts the following analog inputs:

Left and Right Inputs

Controller (with integral exciter)

An analog left/right or monaural input (left only) (30 Hz to 15 kHz, 0 -12 dBm) can be applied to ANALOG AUDIO (L&R)/SCA₃/1PPS (A1J5B) 9-pin male D-sub connector [left (+ on pin 4, - on pin 8), right (+ on pin 2, - on pin 7) and shield on pin 3]. The NV20LT/NV15LT's front panel UI or remote AUI allows for configuration of the audio input mode (left, right or stereo). Provision is made for adjustment of the input sensitivity and pre-emphasis. The input impedance for each input is 600 Ω.

NOTE: Transmitters are factory set to provide 100% modulation (\pm 75 kHz) with an analog L/R input level of precisely 1.24 V rms (4.7 dBu). The analog left and SCA generator 1 inputs use the same connection point and cannot be used at the same time. Similarly, the analog right and SCA generator 2 inputs use the same connection point and cannot be used at the same time.

Standby Exciter (optional)

An analog left/right or monaural input (left only) (30 Hz to 15 kHz, 0 -12 dBm) can be applied to ANALOG AUDIO IN (A1J5) 15-pin, male D-sub connector [left (+ on pin 7, - on pin 8), shield on pin 15, right (+ on pin 13, - on pin 14, shield on pin 6)]. The NV20LT/NV15LT's front panel UI or remote AUI allows for configuration of the audio input mode (left, right or stereo). Provision is made for adjustment of the input sensitivity and pre-emphasis. The input impedance for each input is 600 Ω.

NOTE: Transmitters are factory set to provide 100% modulation (\pm 75 kHz) with an analog L/R input level of precisely 1.24 V rms (4.7 dBu). The analog left and SCA generator 1 inputs use the same connection point and cannot be used at the same time. Similarly, the analog right and SCA generator 2 inputs use the same connection point and cannot be used at the same time.

SCA Generator Input

Controller (with integral exciter)

Dual internal SCA generators can be interfaced via the ANALOG AUDIO (L&R)/SCA₃/1PPS (A1J5B) 9-pin male D-sub connector [SCA1 (+ on pin 4, - on pin 8), SCA2 (+ on pin 2, - on pin 7) and shield on pin 3]. The input impedance is 600 Ω and the adjustment range is 0 to +12 dBu.

NOTE: Transmitters are factory set for a 1.24 V rms (4.7 dBu) SCA generator input level. The SCA generator 1 and analog left inputs use the same connection point and cannot be used at the same time. Similarly, the SCA generator 2 and analog right inputs use the same connection point and cannot be used at the same time.

Standby Exciter (optional)

Internal dual SCA generators can be interfaced via ANALOG AUDIO IN (A1J5) 15-pin male D-sub connector [SCA1 (+ on pin 4, - on pin 5, shield on pin 12) and SCA2 (+ on pin 10, - on pin 11, shield on pin 3)]. The input impedance is 600 Ω and the adjustment range is 0 to +12 dBu.

NOTE: Transmitters are factory set for a 1.24 V rms (4.7 dBu) SCA generator input level.

MPX Input

NOTE: Transmitters are factory set to provide 100% modulation (± 75 kHz) with a wideband composite input level of precisely 1.24 V rms (3.5 V pk-pk).

Controller (with integral exciter)

Balanced and unbalanced wideband MPX (composite) inputs (30 Hz to 100 kHz) are provided on the MPX BAL/UNBAL female BNC connector (A1J7). The UNBAL/BAL jumper (A1E1) inside the transmitter allows selection between balanced (jumper installed between pins 2 and 3) and unbalanced (jumper installed between pins 1 and 2) mode. The default setting is balanced. The levels are nominally 3.5 V pk-pk for ± 75 kHz carrier deviation, adjustable between 0.5 V and 5 V pk-pk. The input impedance is 1200 Ω .

Standby Exciter (optional)

Balanced and unbalanced wideband MPX (composite) inputs (30 Hz to 100 kHz) are provided on the BAL/UNBAL MPX (A1J6) female BNC connector. The UNBAL/BAL jumper (A1E1) inside the exciter allows selection between balanced (jumper installed between pins 2 and 3) and unbalanced (jumper installed between pins 1 and 2) mode. The default setting is balanced. The levels are nominally 3.5 V pk-pk for ± 75 kHz carrier deviation, adjustable between 0.5 V and 5 V pk-pk. The input impedance is 1200 Ω .

NOTE: A 50- Ω input impedance option is available from Nautel. Contact a Nautel Sales representative for more information.

MPX SCA Inputs

NOTE: Transmitters are factory set to provide 10% modulation (± 7.5 kHz) with an SCA input level of precisely 1.0 V rms (2.8 V pk-pk).

Controller (with integral exciter)

Two unbalanced inputs (20 kHz to 100 kHz) are provided on the SCA₁ (A1J6A) and SCA₂/RDS (A1J6B) female BNC connectors, which accept pre-modulated SCA information. The levels are nominally 2.8 V pk-pk for ± 75 kHz carrier deviation, and are adjustable between 0.5 V and 5 V pk-pk. The input impedance for each input is 10 k Ω . A third MPX SCA input can be applied to ANALOG AUDIO (L&R)/SCA₃/IPPS 9-pin male D-sub connector A1J5B (pins 1 and 9).

Standby Exciter (optional)

Two unbalanced inputs (20 kHz to 100 kHz) are provided on the MPX SCA₁ IN (A1J7A) and MPX SCA₂ IN (A1J7B) female BNC connectors, which accept pre-modulated SCA information. The levels are nominally 2.8 V pk-pk for ± 75 kHz carrier deviation, and are adjustable between 0.5 V and 5 V pk-pk. The input impedance for each input is 10 k Ω .

Digital Inputs

The NV20LT/NV15LT accepts the following digital inputs:

AES/EBU Input

Controller (with integral exciter)

The NV20LT/NV15LT accepts AES/EBU digital audio via the AES/EBU IN (A1J3) 3-pin female XLR connector (110 Ω balanced; supports sample rates between 20 and 192 kHz). The NV20LT/NV15LT's UI allows for configuration of the audio input mode (left, right or stereo) and level (in dBFS).

Standby Exciter (optional)

The NV20LT/NV15LT accepts AES/EBU digital audio via the AES/EBU IN ₁ (A1J4) 3-pin female XLR connector (110 Ω balanced; supports sample rates between 20 to 192 kHz). A second AES/EBU input can be applied to the ANALOG AUDIO IN (A1J5) 15-pin male D-sub connector (+ on pin 1, - on pin 2, ground on pin 9). The NV20LT/NV15LT's front panel UI or remote AUI allows for configuration of the audio input mode (left, right or stereo) and level (in dBfs).

RBDS/RDS Input

NOTE: The NV20LT/NV15LT also supports stand-alone RBDS/RDS operation. In this mode, RBDS/RDS parameters are configured through the front panel UI or remote AUI.

Controller (with integral exciter)

The NV20LT/NV15LT accepts ASCII or UECF data for its internal RBDS/RDS generator via RS-232 on the RDS/RBDS (A1J5A) 9-pin female D-type connector. The data is framed and modulated on a 57 kHz sub-carrier, which forms part of the composite signal.

Standby Exciter (optional)

The NV20LT/NV15LT accepts UECF or ASCII data for its internal RBDS/RDS generator via RS-232 on the RDS/RBDS (A1J3A) 9-pin, female D-type connector. The data is framed and modulated on a 57 kHz sub-carrier, which forms part of the composite signal.

Other Features

Carrier Frequency and Pilot Phase Control (10 MHz and 1 PPS IN)

Controller (with integral exciter)

The NV20LT/NV15LT provides carrier frequency and pilot phase control from a precision GPS reference on the 10MHz IN (A1J4B) female BNC connector (between 0.5 V and 2 V pk-pk sine wave input; 50 Ω) and 1PPS on the ANALOG AUDIO (L&R)/SCA3/1PPS (A1J5B) 9-pin male D-sub connector (pins 5 and 6; 5 V TTL input level, 10 k Ω).

Standby Exciter (optional)

The NV20LT/NV15LT provides carrier frequency and pilot phase control from a precision GPS reference on the exciter's 10MHz IN (W2J1) female BNC connector (between 0.5 V and 2 V pk-pk sine wave input; 50 Ω) and 1PPS IN (A1J8A) female BNC connector (5 V TTL input level, 10 k Ω).

Pilot/MPX Sample

Controller (with integral exciter)

The NV20LT/NV15LT provides a 19 kHz pilot sample (500 mV pk-pk) on the PILOT SAMPLE OUT (A1J4A) female BNC connector.

Standby Exciter (optional)

The NV20LT/NV15LT provides either a 19 kHz pilot sample (500 mV pk-pk) or an MPX sample (500 mV pk-pk for ± 75 kHz carrier deviation) on the exciter's PILOT/MPX SAMPLE OUT (A1J8B) female BNC connector. The output is selectable through the front panel UI or remote AUI.

External Audio Playlist via USB

The transmitter can be configured to accept an external audio playlist on a USB drive that is connected to the USB-A (A1J8A) or USB-B (A1J8B) connector on the rear of the controller (A4). When properly configured using the AUI's Presets menu (see the Playlist Manager section of the Operations and Maintenance Manual for details), this playlist will be applied to each exciter's ANALOG AUDIO IN (A1J5) 15-pin D-sub connector via the AUDIO PLAYER AES OUT (A2J3A) 9-pin D-sub connector on the rear of the controller and cable W26.

For connection details, refer to Audio Cable Configuration Options. See [Figure 1.7.3 on page 1.7.9](#).

For preset setting requirements, see the PRESET SETTINGS NOTE in [Figure 1.7.3 on page 1.7.9](#) or see the *Presets - Editing Operational Settings* section of the Operations and Maintenance Manual.

PROGRAM INPUTS

Connector, Type/Gender	Input/Output	Pins	Comments
ANALOG AUDIO/ SCA3/1PPS (A1J5B) 9-pin D-sub, male	Analog Left input	4 (+), 8 (-)	Same connection points as SCA1 and SCA2 input, cannot be used at the same time
	Analog Right input	2 (+), 7 (-)	
	Shield	3	
	SCA1 input	4 (+), 8 (-)	SCA audio for internal SCA generator. Same connection points as analog left and right inputs; cannot be used at the same time
SCA2 input	2 (+), 7 (-)		
	Shield	3	
	MPX SCA3 input	1, 9 (GND)	SCA audio from external SCA generator.
	1PPS input	5, 6 (GND)	Pilot phase control for GPS reference
MPX BAL/UNBAL IN (A1J7) BNC, female	Balanced/unbalanced wideband composite input	-	30 Hz to 100 kHz; nominal 3.5 V pk-pk for ±75 kHz deviation, adjustable between 0.5 and 5 V pk-pk; 10 kohm input impedance. Set UNBAL/BAL jumper A1E1 to select unbalanced (pins 1 and 2) or balanced (pins 2 and 3).
SCA1 (A1J6A) BNC, female	MPX SCA1 input	-	SCA audio from external SCA generator. 20 kHz to 100 kHz; nominal 2.8 V pk-pk for ±75 kHz deviation, adjustable between 0.5 and 5 V pk-pk; 10 kohm input impedance
SCA2/RDS (A1J6B) BNC, female	MPX SCA2 input	-	SCA audio from external SCA generator. 20 kHz to 100 kHz; nominal 2.8 V pk-pk for ±75 kHz deviation, adjustable between 0.5 and 5 V pk-pk; 10 kohm input impedance
AES/EBU IN (A1J3) XLR, female	AES/EBU digital audio input	-	Left and/or right audio input. 110 ohms balanced; supports sample rates between 20 and 192 kHz
RDS/RBDS (A1J5A) 9-pin D-sub, female	ASCII or UECP data via RS-232 interface	1 (DCD) 2 (RXD) 3 (TXD) 4 (DTR) 5 (GND) 6 (DSR) 7 (RTS) 8 (CTS) 9 (RI)	Data used for internal RDS/RBDS generator
10MHz IN (A1J4B) BNC, female	10 MHz GPS reference	-	0.5 to 2 V pk-pk sine wave, 50 ohm
PILOT SAMPLE OUT(A1J4A) BNC, female	19 kHz pilot sample	-	500 mV pk-pk (sine wave)

RF MONITOR SAMPLE

True RF sample of the exciter's RF drive output (approximately -39 dB), relative to the carrier level. Intended for modulation monitoring. Not intended for harmonic spectral compliance testing.

REMOTE CONTROL/ MONITORING

REMOTE I/O-A (A1J2A) 25-pin male D-sub
 10 Digital Inputs (see Section 8 for factory defaults)
 4 +15 V Configuration (see Section 8)
 2 Ground pins (see Section 8)
 2 External Interlock (pins 19, 20)
REMOTE I/O-B (A1J2B) 25-pin female D-sub
 16 Digital Output (see Section 8 for factory defaults)
 4 Analog Outputs (see Section 8 for factory defaults)
 4 Ground pins (see Section 8)

LAN INTERFACE

Allows web-based AUI control. See Section 8 for more information

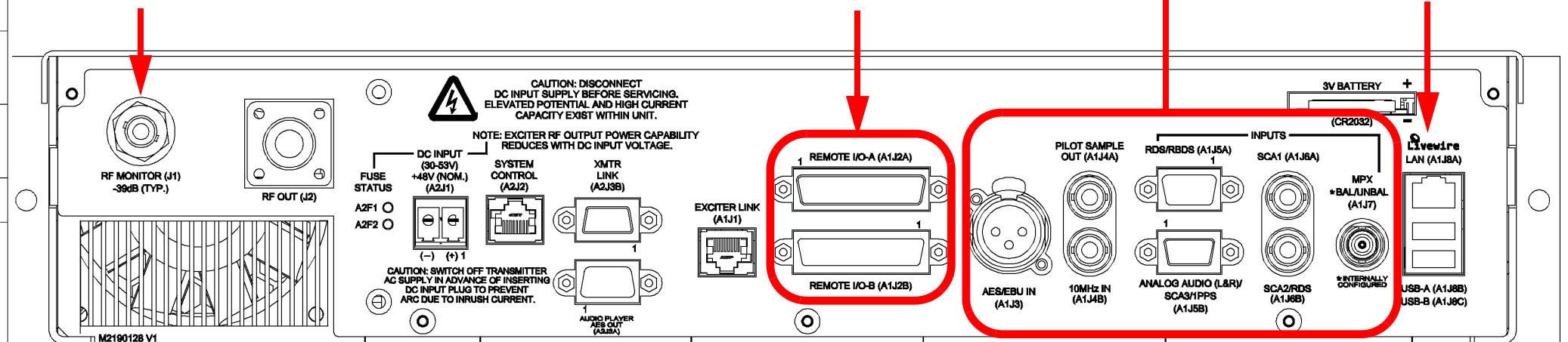
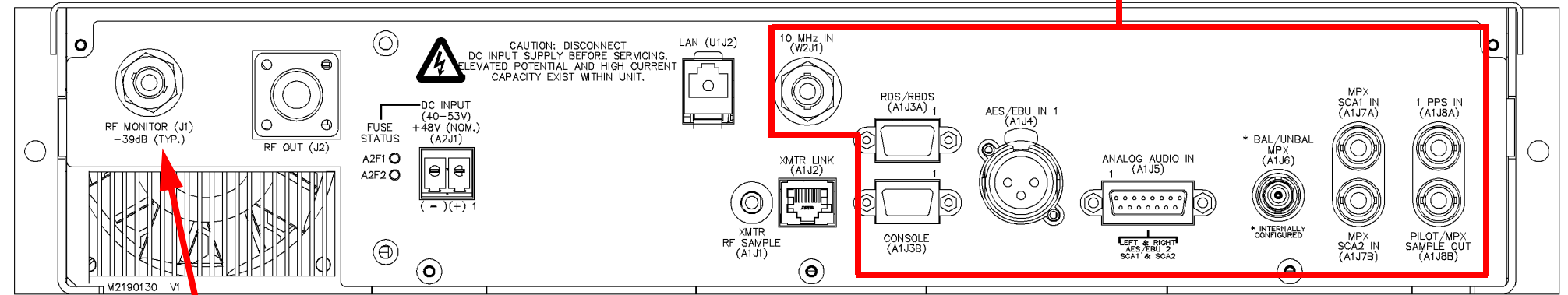

Figure 1.7.1: NAE106E Controller (with integrated exciter) Rear Panel Customer Connections

PROGRAM INPUTS

Connector, Type/Gender	Input/Output	Pins	Comments
RDS/RBDS (A1J3A) 9-pin D-sub, female	ASCII or UECP data via RS-232 interface	1 (DCD) 2 (RXD) 3 (TXD) 4 (DTR) 5 (GND) 6 (DSR) 7 (RTS) 8 (CTS) 9 (RI)	Data used for internal RDS/RBDS generator
AES/EBU IN 1 (A1J4) XLR, female	AES/EBU digital audio input	-	Left and/or right audio input. 110 ohms balanced; supports sample rates between 20 and 192 kHz
ANALOG AUDIO IN (A1J5) 15-pin D-sub, male	Analog AES/EBU 2 input Shield Analog Left input Shield Analog Right input Shield SCA1 input Shield SCA2 input Shield	1(+), 2 (-) 9 7(+), 8 (-) 15 13 (+), 14 (-) 6 4 (+), 5 (+) 12 10 (+), 11 (-) 3	Left and/or right audio input. 110 ohms balanced; supports sample rates between 20 and 192 kHz SCA audio for internal SCA generator. SCA audio from external SCA generator.
BAL/UNBALMPX (A1J6) BNC, female	Balanced/unbalanced wideband composite input	-	30 Hz to 100 kHz; nominal 3.5 V pk-pk for ± 75 kHz deviation, adjustable between 0.5 and 5 V pk-pk; 10 kohm input impedance. Set UNBAL/BAL jumper A1E1 to select unbalanced (pins 1 and 2) or balanced (pins 2 and 3).
MPX SCA1 IN (A1J7A) BNC, female	MPX SCA1 input	-	SCA audio from external SCA generator. 20 kHz to 100 kHz; nominal 2.8 V pk-pk for ± 75 kHz deviation, adjustable between 0.5 and 5 V pk-pk; 10 kohm input impedance
MPX SCA2 IN (A1J7B) BNC, female	MPX SCA2 input	-	SCA audio from external SCA generator. 20 kHz to 100 kHz; nominal 2.8 V pk-pk for ± 75 kHz deviation, adjustable between 0.5 and 5 V pk-pk; 10 kohm input impedance
1 PPS IN (A1J8A) BNC, female	1 PPS input	-	Pilot phase control for GPS reference
PILOT/MPX SAMPLE OUT (A1J8B) BNC, female	19 kHz pilot sample	-	500 mV pk-pk (sine wave)
10MHz IN (W2J1) BNC, female	10 MHz GPS reference	-	0.5 to 2 V pk-pk sine wave, 50 ohm



RF DRIVE MONITOR SAMPLE

True RF sample of the exciter's RF drive output (approximately -39 dB), relative to the carrier level. Intended for modulation monitoring. Not intended for harmonic spectral compliance testing.

Figure 1.7.2: NAE107* Exciter Rear Panel Customer Connections

Breakout Cable Option - uses 206-5062 Audio Breakout Cable (no USB backup audio) - remove W26

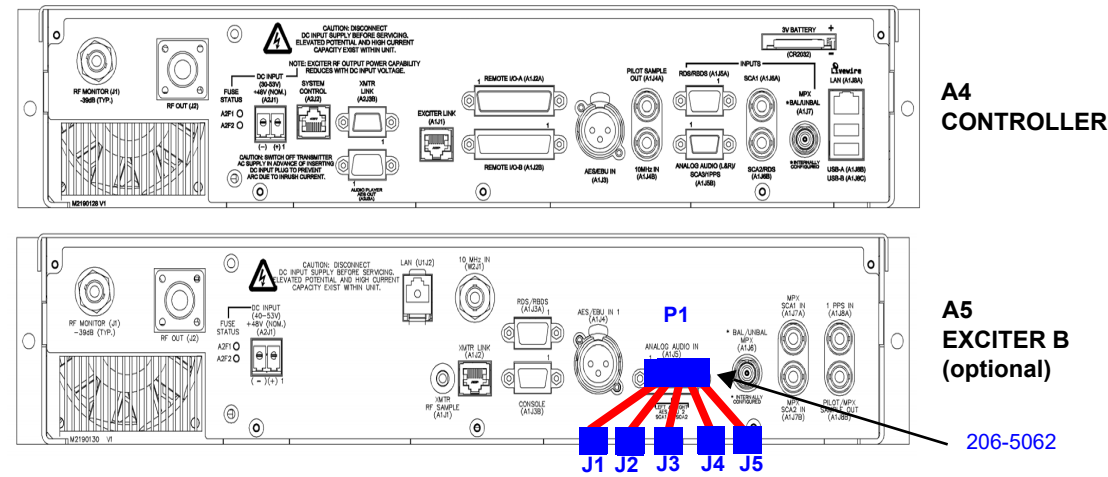

Standard Configuration - Uses existing W26 cable (with USB backup audio)

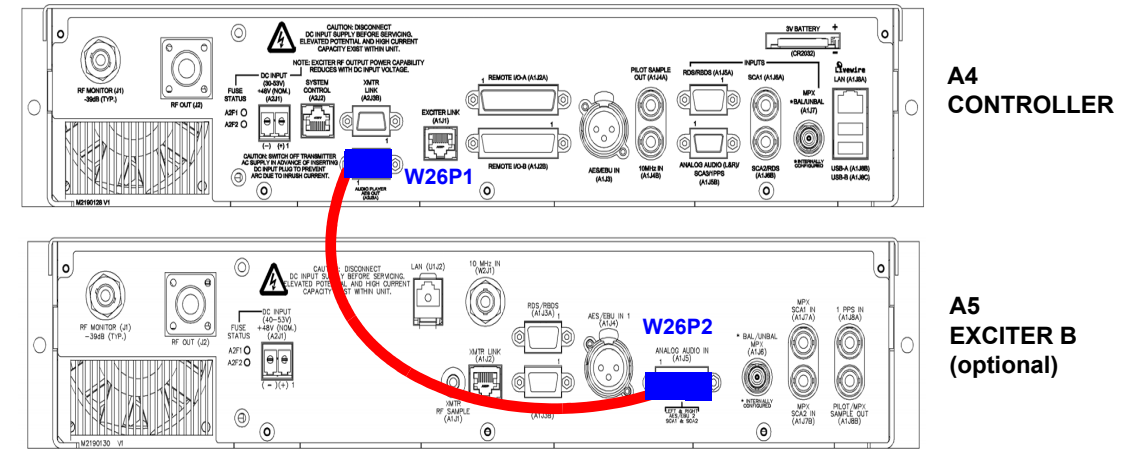

NOTE:
Standard Configuration is only applicable when the Dual Exciter option is purchased.

NOTE:

The Audio Breakout Cable Assembly and the USB Backup Patch Cable Assembly are located in the Audio Cable Kit (Nautel Part # 219-5050) which is packed in the ancillary kit sent with the transmitter.

Breakout Cable Option (with USB backup audio) - uses 206-5068 USB Backup Patch Cable and 206-5062 Audio Breakout Cable - remove W26

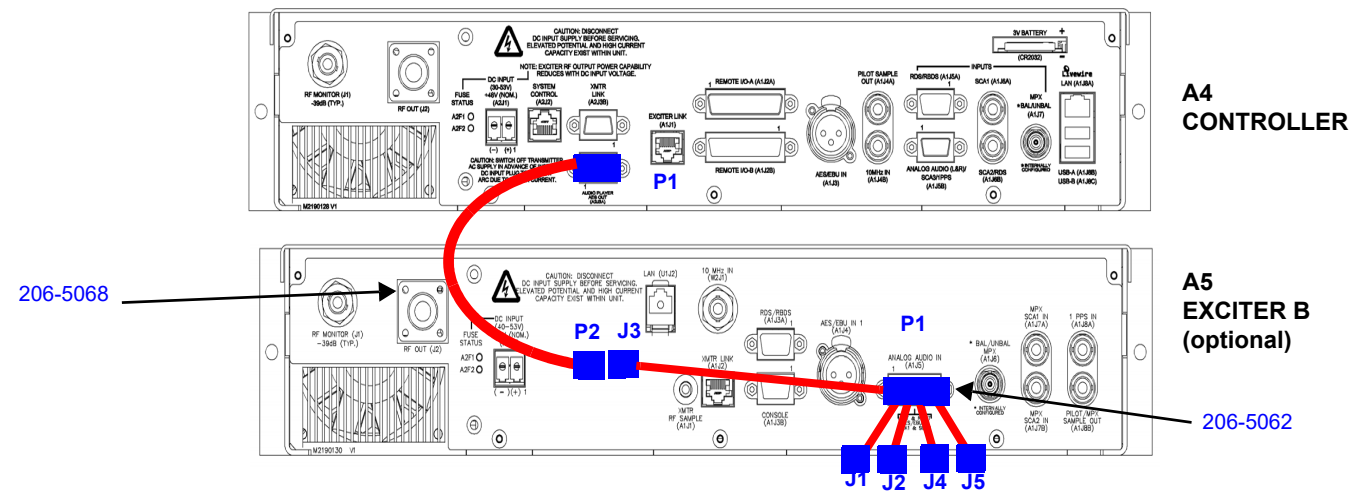

NOTE: PRESET SETTINGS

The configurations shown apply to presets that have the Main Audio -> Audio Source set to Audio Player -> AES 2.

Another configuration is possible by connecting P2 and P3 of USB Backup Patch Cable 206-5068 to the AES/EBU IN 1 (A1J4) connector on exciter B. In this case, the preset's Main Audio -> Audio Source must be set to Audio Player -> AES 1.

NOTE:

The Audio Breakout Cables (Nautel Part # 206-5062 & 206-5068) do not come with the transmitter and must be purchased separately.

Figure 1.7.3: Audio Cable Configuration Options

SECTION 1.8: PLANNING FOR CONTROL AND MONITORING

This section describes the types of control and monitoring for the NV20LT/NV15LT transmitter. Consider the following information and plan for the necessary requirements (wiring, remote switches/ indicators, LAN, etc.):

- [Front Panel UI Control](#)
- [Remote Control](#)
- [Remote Inputs - see page 1.8.4](#)
- [Remote Outputs - see page 1.8.8](#)
- [Analog Outputs - see page 1.8.11](#)
- [Web Based Control - see page 1.8.13](#)
- [SNMP Control/Monitoring - see page 1.8.14](#)
- [Nautel Phone Home - see page 1.8.15](#)
- [External Interlock - see page 1.8.16](#)

Front Panel UI Control

The NV20LT/NV15LT's front panel user-interface (UI) lets you locally control a number of transmitter functions and set parameters. For detailed information about the front panel UI, refer to the NV20LT/NV15LT Operating and Maintenance Manual.

Remote Control

Controller (with integrated exciter)

The front panel UI or remote AUI lets you define and control the on/off status, the preset RF power level, and the system alarm reset, remotely using a conventional remote control interface (see "[Remote Inputs](#)" and "[Remote Outputs](#)" on page 1.8.8) or a LAN (see "[Web Based Control](#)" on page 1.8.13).

The controller (A4) rear panel has two 25-pin D-sub connectors - REMOTE I/O-A (A1J2A) and REMOTE I/O-B (A1J2B) - that facilitate these connections. You can interface with the transmitter with up to ten remote control inputs, 16 remote monitoring outputs, four analog sample outputs and an external interlock. The remote inputs and outputs have factory defaults, but are also user-configurable through the remote AUI. See [Figure 1.7.1: on page 1.7.7](#) to locate these connectors and see [Table 1.8.1 on page 1.8.7](#) and [Table 1.8.2 on page 1.8.9](#) for pin-out details.

Other features the Remote I/O function offers are:

- Summary Alarms (see [“Remote Outputs” on page 1.8.8](#) and Table 4.1.1 in the Troubleshooting manual for details).
- Active Audio Path Status (selective between MPX, AES1, AES2 and L/R Audio Active). Not default outputs, must be configured by user.
- Remote Alarm Reset (resets any latched protection circuits which allows the transmitter to return to an RF on state).

Using the controller as the remote interface involves routing wiring through the top of the transmitter and down to the rear of the controller module.

Remote Interface PWB (Optional)

If you installed the optional remote interface PWB (see [Figure 1.8.1](#)), you can interface with the transmitter similarly to the controller, but with improved convenience, as the remote interface PWB is located behind the hinged, UI front panel, near a wiring entry point at the top of the transmitter cabinet. The remote interface PWB also contains push-button control switches and status LEDs, which provide an additional (backup) means to control and monitor the inputs and outputs as well as analog samples for forward power, reflected power, PA voltage and total PA current.

Figure 1.8.1: Remote Interface PWB Location and Connections

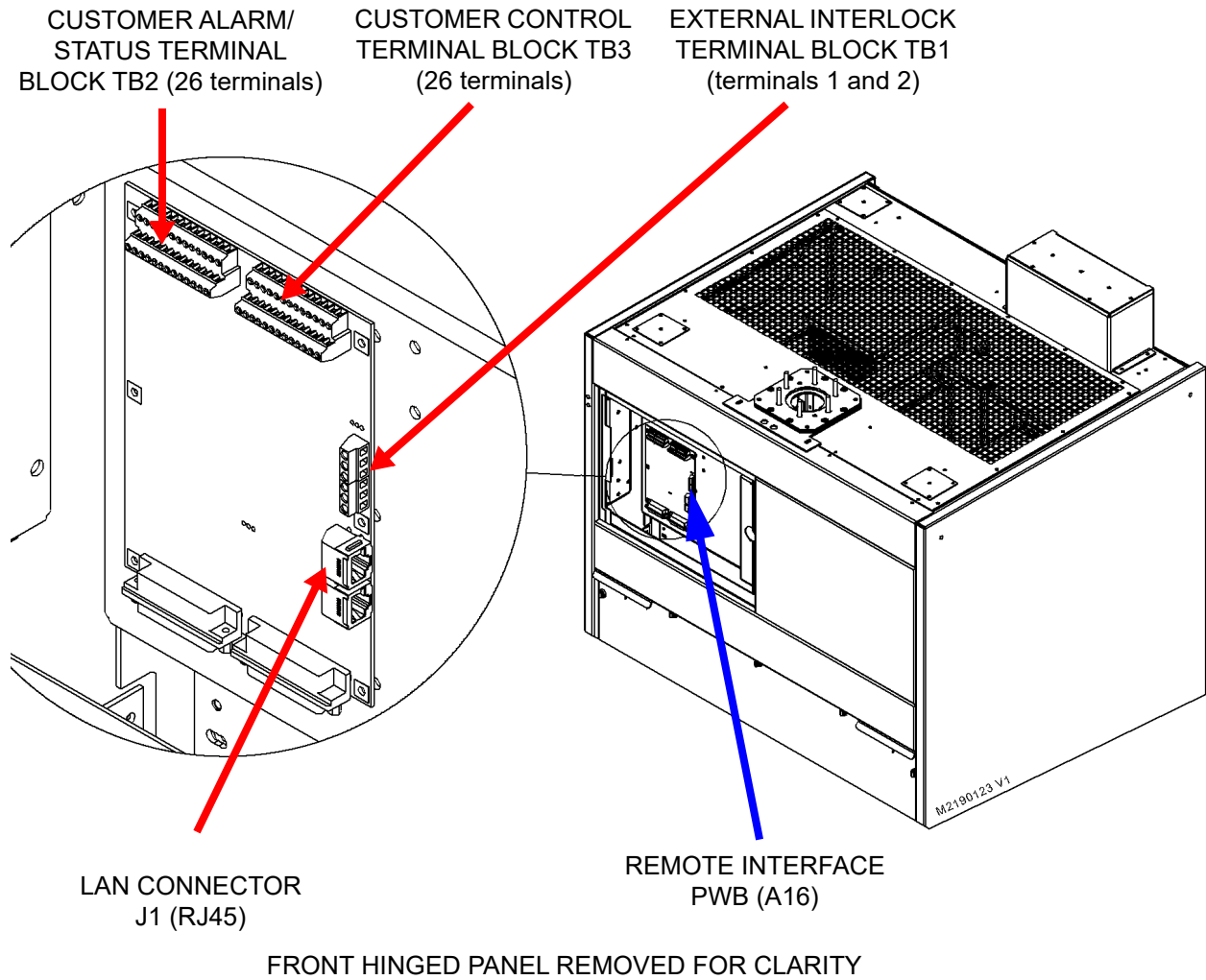

Remote Inputs

You can connect to ten remote inputs, which allow you to remotely control various operational characteristics of the transmitter. Each input is mapped to a control that is preset at Nautel, but is also user-configurable. See [Table 1.8.1 on page 1.8.7](#) for a list of the preset inputs, their default functional descriptions and their associated input pins on the REMOTE I/O-A (A1J2A) 25-pin male D-sub connector on the rear of the controller (A4) or the CUSTOMER CONTROL terminal block (TB3) on the optional remote interface PWB (A16). Refer to the NV20LT/NV15LT Operations and Maintenance Manual for instructions on changing the remote input settings. Unless otherwise noted these inputs are only accepted by the transmitter if remote control is enabled. That setting can only be made by a local user using the front panel push-button. All inputs are active when a ground (0 V) is applied.

The external remote input circuits interface with the transmitter via the applicable D-sub connector or terminal block and then with opto-couplers on the exciter/controller PWB (A4A1), within the controller. The opto-couplers buffer and isolate the external circuits and prevent any unwanted transients from affecting transmitter operation while remote control is selected at the transmitter.

Nautel provides the appropriate gender of mating connectors (Nautel Part # JS28 and JS31) and connector shells (Nautel Part # JS35) in the ancillary parts kit to facilitate customer connections to the controller's D-sub connector, as applicable.

External Switching Circuit Requirements

The switching circuits for the remotely controlled functions must be the equivalent of a normally open (momentary) switch. The switches must be configured to operate as a single-ended input using the transmitter's 15 V dc as the source [see ["Internal Dc Supply Selected"](#)] or as a differential input using an external dc power supply (12 - 18 V) applied to the controller (A1J2A-9 and A1J2A-21) or the optional remote interface PWB (TB3-9 and TB3-21) [see ["Option 2 - External Dc Supply" on page 1.8.6](#)]. The optional remote interface PWB (A16) contains a selection circuit that lets you select internal or external dc power supply for all remote inputs.

Inputs are toggled between states by an active pulse unless otherwise noted. To ensure proper operation, the duration of the active pulse should be a minimum of 250 ms. Refer to the NV20LT/NV15LT Operations and Maintenance Manual to see the various logic control options for remote inputs.

Option 1 - Internal Dc Supply

When you use the transmitter's 15 V as the source for a control function's opto-coupler, do one of the following, as applicable:

- ❖ If the controller is your remote interface, connect pins A1J2A-10 and A1J2A-22 to pins A1J2A-9 and A1J2A-21 respectively (see Figure 1.8.2) to configure the circuit.
- ❖ If the optional remote interface PWB is your remote interface, configure its circuits for internal dc power supply by installing the INT/EXT 3-pin header's (E2) 2-socket shunt post in the INT position (between pins 2 and 3).

When the remote input is configured for logic '0', a negative logic (current-sink-to-ground) command must be applied to the appropriate remote input (1 through 10). To avoid a ground loop, obtain the ground from either the controller (A1J2A, pins 19 and 23) or optional remote interface PWB (TB3, terminals 3, 6, 11, 16, 19, 23, 25 or 26).

Figure 1.8.2: Internal Dc Supply Selected

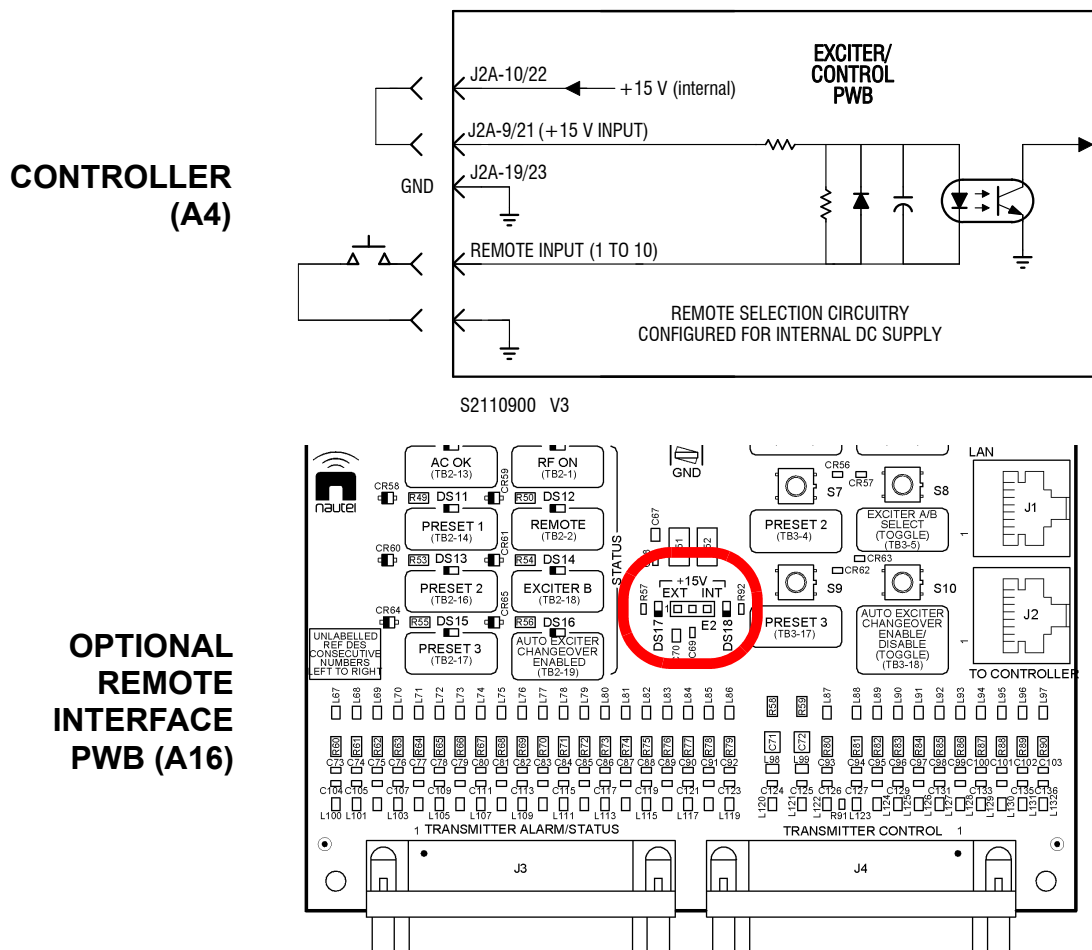

Option 2 - External Dc Supply

When you use an external dc voltage (12 V to 18 V) as the source for a control function's opto-coupler, configure the control function's external switching circuit for an external dc supply as follows:

- ❖ If the controller is your remote interface, connect the external dc supply to A1J2A pins 9 and 21 (see Figure 1.8.3 on page 1.8.6) to configure the circuit.
- ❖ If the optional remote interface PWB is your remote interface, configure its circuits for external dc power supply by installing the INT/EXT 3-pin header's (E2) 2-socket shunt post in the EXT position (between pins 1 and 2).

Figure 1.8.3: External Dc Supply Selected

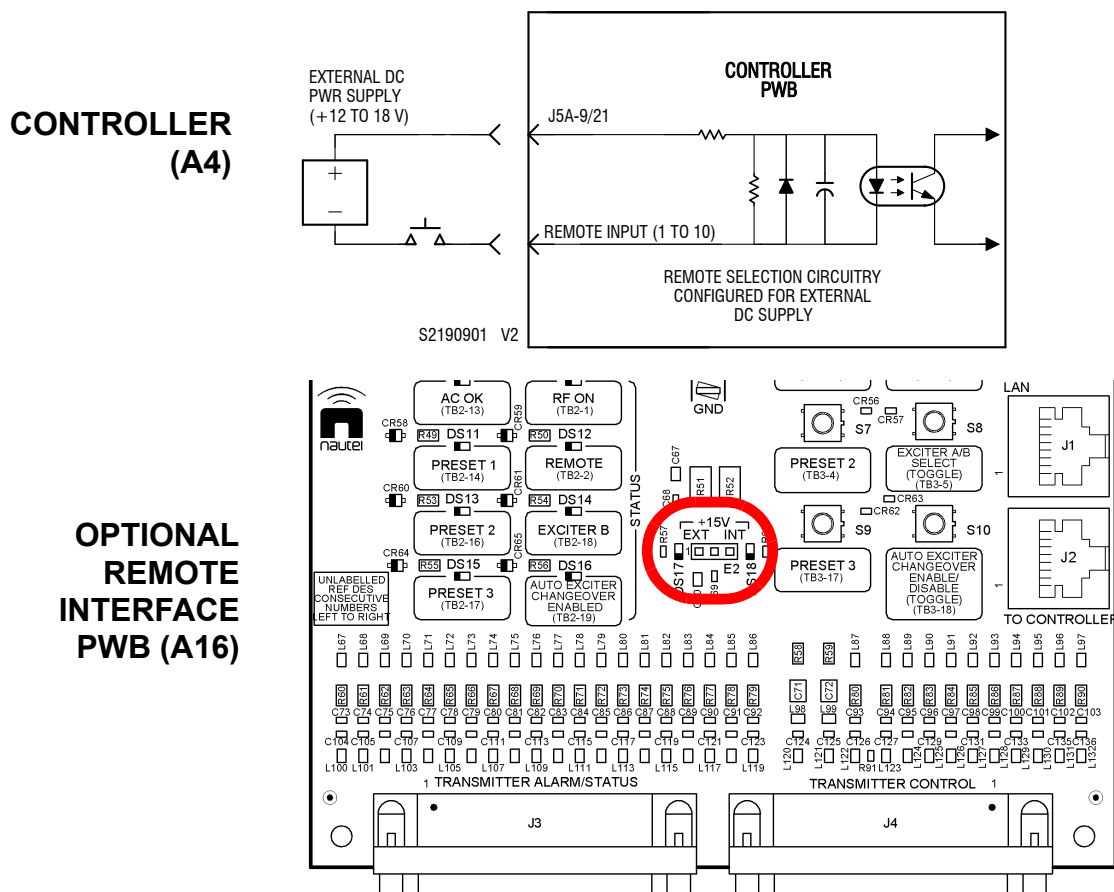

CAUTION! When connecting an external supply, ensure that pins 10 and 22 of A1J2A are disconnected from pins 9 and 21 of A1J2A. Failure to observe this may result in damage to the internal supply and other circuitry.

The normally open/momentarily closed switch should be located between the dc supply's negative output and the remote input.

Backup Control Switches

The optional remote interface PWB (A16) contains a push-button switch S1 through S10 for various control functions. Each switch provides a means to locally activate its associated function in the event that the associated AUI control is not available or local UI is inoperable. See [Table 1.8.1](#) to determine the switch and factory configured control function (e.g., RF on, Preset 2, Power Increase, etc.) associated with each of the digital inputs. Below each switch is a silk-screened label of the factory configured (default) name of the control switch. If you change the configuration of a particular digital input, you can obtain a suitable adhesive label and rename the associated control switch.

Table 1.8.1: Factory Defined Remote Inputs

REMOTE INPUT #	DEFAULT INPUT (CHANNEL)	FUNCTION	CONTROLLER (A4)	REMOTE INTERFACE PWB (A16)	
			PIN OF A1J2A	TERMINAL	SWITCH
1	RF On	Same as pressing the RF On button. Tells the transmitter to provide RF power if possible.	A1J2A-7	TB3-7	S1
2	RF Off	Same as pressing the RF Off button. Tells the transmitter to disable RF power.	A1J2A-8	TB3-8	S2
3	Power Increase	Increases the power level of the current preset. Apply a momentary ground input to increase the power by 1% of rated, or apply a longer duration ground input to increase power by 1% every 0.5 s.	A1J2A-14	TB3-14	S3
4	Power Decrease	Decreases the power level of the current preset. Apply a momentary ground input to decrease the power by 1% of rated, or apply a longer duration ground input to decrease power by 1% every 0.5 s.	A1J2A-2	TB3-2	S4
5	Preset 1 Select	Selects preset 1 as active.	A1J2A-15	TB3-15	S5
6	Reset	Causes a system reset.	A1J2A-1	TB3-1	S6
7	Preset 2 Select	Selects preset 2 as active.	A1J2A-4	TB3-4	S7
8	Exciter A/B Select	For dual exciter configurations, toggles between selecting exciter A or B as the active exciter.	A1J2A-5	TB3-5	S8
9	Preset 3 Select	Selects preset 3 as active.	A1J2A-17	TB3-17	S9
10	Auto Exciter Changeover Enable/Disable	For dual exciter configurations, toggles between enabling/disabling the auto exciter changeover circuit.	A1J2A-18	TB3-18	S10
-	-	Ground	A1J2A-19,23	TB3-3,6,11, 16, 19,23,25,26	-

Remote Outputs

Up to 16 remote outputs, that indicate either the presence of various alarms or the status of operator controlled circuits, are available for remote monitoring on either the REMOTE I/O-B (A1J2B) 25-pin female D-sub connector on the rear of the controller (A4) or the CUSTOMER ALARM/STATUS terminal block (TB2) on the optional remote interface PWB (A16) (see [Figure 1.8.1 on page 1.8.3](#)). The sources and active logic levels of these remote outputs are preset at Nautel, but are also user-configurable. Any available alarm can be mapped to a remote output pin. See [Table 1.8.2 on page 1.8.9](#) for a list of the factory preset outputs, their descriptions and their associated output pins on the controller or optional remote interface PWB and the status LEDs (see "[Backup Monitoring LEDs](#)") on the optional remote interface PWB.

A switching device for each remote output, configurable through the AUI, provides the desired active logic state, when a true condition exists.

For example, if a remote output is configured as Output Low When On (see the NV20LT/NV15LT Operations and Maintenance Manual for the specific text displayed on the AUI), then the remote output's switching circuit will provide a current-sink-to-ground when a logic true (on) condition exists and an open collector for a logic false (off) condition.

If the remote output is configured as Output Low When Off (see the NV20LT/NV15LT Operations and Maintenance Manual for the specific text displayed on the AUI), then the remote output's switching circuit will provide an open collector when a logic true (on) condition exists and a current-sink-to-ground for a logic false (off) condition.

Each switching circuit must present impedance between the switching device and a dc voltage source that limits current flow to no more than 30 mA. Each circuit's positive voltage source must not exceed 23 V dc. The internal +15 V supply is capable of providing 100 mA for all active status outputs. If you require more current capability, use an appropriate external power supply.

Nautel provides the appropriate gender of mating connectors (Nautel Part # JS28 and JS31) and connector shells (Nautel Part # JS35) in the ancillary parts kit to facilitate customer connections to the controller's D-sub connector, as applicable.

Backup Monitoring LEDs

The remote interface PWB (A16) contains LEDs (DS1 through DS16) that provide specific status and alarm indications. See [Table 1.8.2 on page 1.8.9](#) to determine the LED and factory configured status parameter (e.g., Summary alarm, RF on status, Preset 3 status, etc.) associated with each of the remote outputs.

Below each LED is a silk-screened label of the factory configured (default) name of the LED status. If you change the configuration of a particular remote output, you can obtain a suitable adhesive label and rename the associated status LED.

Table 1.8.2: Factory Defined Remote Outputs

REMOTE OUTPUT #	DEFAULT OUTPUT (CHANNEL)	DESCRIPTION	CONTROLLER (A4)	REMOTE INTERFACE PWB (A16)	
			PIN OF A1J2B	TERMINAL	LED
1	Overall Summary	Logic true condition (low or current-sink-to-ground) indicates that any alarm is occurring.	A1J2B-3	TB2-3	DS1 (red)
2	External Interlock Open	Logic true condition (low or current-sink-to-ground) indicates the RF output is inhibited because an external interlock switch has been opened.	A1J2B-4	TB2-4	DS2 (red)
3	High Temperature Summary	Logic true condition (low or current-sink-to-ground) indicates there is a high temperature condition detected by one of the monitoring circuits OR the transmitter is operating at reduced power due to fan failure(s).	A1J2B-6	TB2-6	DS3 (red)
4	External Summary	Logic true condition (low or current-sink-to-ground) indicates that something external to the transmitter is in a fault condition (e.g., transmitter interlock, audio loss, etc.).	A1J2B-7	TB2-7	DS4 (red)
5	Low Forward Power	Logic true condition (low or current-sink-to-ground) indicates the RF output power is below the user configurable threshold (default is 50%).	A1J2B-8	TB2-8	DS5 (red)
6	High Reflected Summary	Logic true condition (low or current-sink-to-ground) indicates that the peak reflected power is exceeding 560 W and/or the transmitter is in an SWR foldback, SWR shutback or SWR shutdown state.	A1J2B-9	TB2-9	DS6 (red)
7	Power Amplifier Summary	Logic true condition (low or current-sink-to-ground) indicates that a fault is occurring that is related to the PA section of any RF power module.	A1J2B-11	TB2-11	DS7 (red)
8	Power Supply Summary	Logic true condition (low or current-sink-to-ground) indicates that a power supply related fault (e.g., LVPS fault, RF power module power supply fault, etc.) is occurring.	A1J2B-12	TB2-12	DS8 (red)
9	AC Summary	Logic true condition (low or current-sink-to-ground) indicates the ac input voltage is being applied and is within the acceptable range.	A1J2B-13	TB2-13	DS9 (amber)

REMOTE OUTPUT #	DEFAULT OUTPUT (CHANNEL)	DESCRIPTION	CONTROLLER (A4)	REMOTE INTERFACE PWB (A16)	
			PIN OF A1J2B	TERMINAL	LED
10	RF On/Off	Indicates the on/off status of the transmitter’s RF power stage. Logic true (low or current-sink-to-ground) is RF is enabled. Logic false (high or open collector) is RF is disabled.	A1J2B-1	TB2-1	DS10 (amber)
11	Preset 1	Indicates that preset 1 is currently active. Logic low (current-sink-to-ground) if active (inactive presets are open collector).	A1J2B-14	TB2-14	DS11 (amber)
12	Remote Enabled	Indicates the local/remote control status of the transmitter. Changes can only be made remotely if the transmitter is set to remote mode. The local user’s control of transmitter operation is limited, unless the transmitter is set to local mode. The local RF off command is always active, regardless of local/remote status. Logic high (open collector) if transmitter is in local mode. Logic low (current-sink-to-ground) if transmitter is in remote mode.	A1J2B-2	TB2-2	DS12 (amber)
13	Preset 2	Indicates that preset 2 is currently active. Logic low (current-sink-to-ground) if active (inactive presets are open collector).	A1J2B-16	TB2-16	DS13 (amber)
14	Active Exciter	Indicates which exciter is presently active. Logic high (open collector) if exciter A is active. Logic low (current-sink-to-ground) if exciter B is active.	A1J2B-18	TB2-18	DS14 (amber)
15	Preset 3	Indicates that preset 3 is currently active. Logic low (current-sink-to-ground) if active (inactive presets are open collector).	A1J2B-17	TB2-17	DS15 (amber)
16	Auto Changeover	Indicates the enabled/disabled status of the auto exciter changeover circuitry. Logic high (open collector) if automatic exciter changeover is disabled. Logic low (current-sink-to-ground) if automatic exciter changeover is enabled.	A1J2B-19	TB2-19	DS16 (amber)
-	-	Ground	A1J2A-19,23	TB2-5,10,15,20,25,26	-

Analog Outputs

The transmitter provides sample signals that let you monitor performance. The sources of these analog outputs are pre-defined and are not user-configurable. See [Table 1.8.3](#) for a list of these outputs, their descriptions and their associated output pins on the REMOTE I/O-B (A1J2B) 25-pin female D-sub connector on the rear of the controller (A4) or the CUSTOMER ALARM/STATUS terminal block (TB2) on the optional remote interface PWB (A16) (see [Figure 1.8.1 on page 1.8.3](#)). The outputs are op-amp buffered outputs from a digital-to-analog converter (DAC) on the exciter/controller PWB (A4A1), within the controller (A4). The dc voltage of each output is between 0 and a maximum of 6 V (full-scale deflection can be scaled by the user; 6 V is default), and varies linearly within the real limits of the parameter being monitored. The monitoring circuit’s impedance for each analog output must be greater than 1,000 ohms.

Analog Output Connections

The four analog outputs connect to pins of CUSTOMER ALARM/STATUS terminal block TB2 on the remote interface PWB (A16) (see [Figure 1.8.1 on page 1.8.3](#)). See [Table 1.8.3](#) to determine the pin or terminal associated with each analog output. Ground/shield connections are available on pins or terminals 5, 10, 15, 20 and 25.

Nautel provides a D-sub mating connector (Nautel Part # JS31) and connector shell (Nautel Part # JS35) in the ancillary parts kit to facilitate customer connections to the controller, as applicable.

Table 1.8.3: Analog Outputs

ANALOG OUTPUT	DESCRIPTION	CONTROLLER (A4)	REMOTE INTERFACE PWB (A16)	
		PIN OF A1J2B	TERMINAL	TEST POINT
Forward Power	Reports a sample of the transmitter’s forward power. This dc voltage is a linear function and is full-scale (default is 6 V; user-configurable from 0 to 6 V) when the forward power is 24 kW.	A1J2B-21	TB2-21	TP2
Reflected Power	Reports a sample of the transmitter’s reflected power. This dc voltage is a linear function and is full-scale (default is 6 V; user-configurable from 0 to 6 V) when the reflected power is 2400 W (NV20LT) or 1800 W (NV15LT).	A1J2B-22	TB2-22	TP3
Average PA Voltage	Reports a sample of the PA voltage. This dc voltage is a linear function and is full-scale (default is 6 V; user-configurable from 0 to 6 V) when the PA voltage is 60 V.	A1J2B-23	TB2-23	TP4
Total PA Current	Reports a sample of the total dc current of the final RF power stage amplifiers. This dc voltage is a linear function and is full-scale (default is 6 V; user-configurable from 0 to 6 V) when the dc current is 900 A (NV20LT) or 676 A (NV15LT).	A1J2B-24	TB2-24	TP5

RF Monitor Sample

A true RF sample of the RF output voltage waveform is available for external monitoring at W8J1, located behind the hinged, front UI panel. Figure 1.8.4 shows the frequency response of the RF monitor sample's coupler. The coupler yields approximately -49 dB (± 1.5 dB), relative to the carrier level, at the FM broadcast carrier frequency (87.5 - 108 MHz). Note that there is a "boost" in the coupler response at higher order (harmonic) frequencies. This boost can be up to +15 to +20 dB relative to the carrier frequency. Subtract the boost value, determined from Figure 1.8.4, from any harmonic measurements made from this sample port. NOTE: there is up to ± 3 dB tolerance on the boost values.

You can approximate the RF monitor sample harmonic response using a 6 dB/octave relationship (e.g., if the sample level is -49 dB at 108 MHz, it will be approximately -43 dB at 216 MHz, or twice the frequency).

The RF monitor sample is intended for reference use only. Nautel recommends that you use an external, calibrated spectrum analyzer to perform certification tests.

Figure 1.8.4: RF Monitor Sample Frequency Response

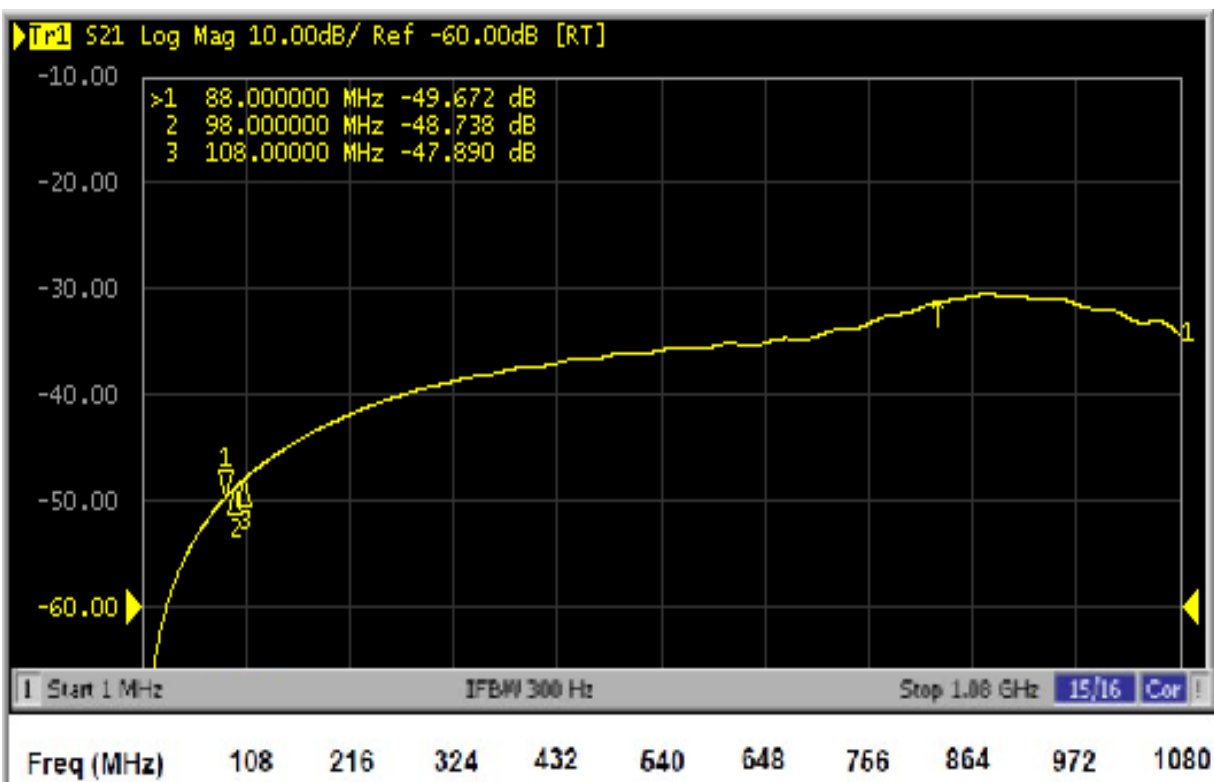

Web Based Control

An Ethernet port is available on the LAN connector (A1J8A) on the rear of the controller (A4) or on the LAN connector (J1) on the optional remote interface PWB (A16) (see [Figure 1.8.1 on page 1.8.3](#)). This port allows a user with proper authentication to remotely control and interrogate the NV20LT/NV15LT's operational status. Most of the functionality available on the front panel UI and more is available remotely, provided the user has been granted proper authorization (refer to the NV20LT/NV15LT Operations and Maintenance Manual for details on setting user permissions). Nautel recommends you use shielded Cat5 cable or better to make this connection.

Remote Access

The only access to the AUI is through the LAN connector on the rear of the controller or on the optional remote interface PWB.

For security purposes, Nautel recommends you place your transmitter behind a router acting as a firewall. To allow remote AUI access to a transmitter behind a firewall, the firewall must allow TCP traffic through the following ports:

- TCP port 80: required to allow the web browser operating on the remote computer to access the web server operating on the transmitter.
- TCP port 3501: used for regular AUI-to-transmitter communication.
- TCP port 7005: Used for RDS/RBDS communication.
- TCP ports 161 and 162: Used for Agents and Traps SNMP, respectively.
- UDP port 123: Used as the NTP port for time synchronization.

For security purposes, Nautel recommends you block the following port:

TCP port 22: block during normal operation; when required, may be used to allow Secure Shell (SSH) programs such as PuTTY, etc. to access the transmitter.

Once your transmitter is isolated behind a firewall, there are a variety of standard network management techniques that can be used to establish a connection, including routing tables and a virtual private network (VPN).

Detailed information about network management is beyond the scope of this manual. Selecting a specific technique often depends on your existing network configuration. Nautel recommends that the planning, implementation and ongoing support of a network that includes a transmitter be undertaken by a team that includes at least one member with suitable knowledge of network management.

NOTE: If you have more than one transmitter on the same LAN, you will need to use port forwarding to allow access to individual transmitters on the network.

SNMP Control/Monitoring

SNMP (Simple Network Management Protocol) is a request-response protocol where the client and agent communicate using binary packets. For Nautel transmitters, SNMP is used to communicate transmitter control commands (e.g., RF on/off, active preset, power adjustments, etc.) as well as monitor data such as alarm states and meter values. Although there are three different versions of the protocol in widespread use (SNMPv1, SNMPv2c and SNMPv3), Nautel only supports SNMPv1.

Nautel provides the central software component, the SNMP agent, which is a program that runs on the transmitter. The SNMP agent interacts with SNMP client software applications, which range from simple MIB browser applications like the free one provided by iReasoning to customized solutions such as those provided by Burk. Nautel does not provide SNMP client software.

Access to SNMP control/monitoring is through the RJ45 LAN connector (A1J8A) on the rear of the controller (A4). When you log into the remote AUI, you can access the User Settings -> SNMP Configuration page to set the SNMP Agent Port number, Read Community and Write Community passwords and SNMP Trap information.

If you are planning to use SNMP, contact Nautel to obtain MIB files for your client software.

MIB files are available through Nautel's FTP site: ftp://www3.nautel.com/SNMP_MIBs/

Email Server

The transmitter's remote AUI allows you to configure an email notification feature, which can initiate emails to specified users when specific alarm or status conditions occur (refer to the NV20LT/NV15LT Operations and Maintenance Manual for details).

The NV20LT/NV15LT supports email servers that are unsecure and secure; requiring authentication (user name/password) as well as encryption. Consult with your network administrator for more details.

Nautel Phone Home

Phone Home is a system developed by Nautel that takes advantage of the vast amount of data collected by Nautel transmitters by proactively sending information to Nautel via the internet once a user enables Phone Home on their transmitter.

This data includes logs, alarms and meter readings which are then stored in a database and can be analyzed by Nautel Customer Service if an alarm is reported by the transmitter. Since all data is pushed out to Nautel by the transmitter, there is no need to reconfigure your firewall and potentially compromise your transmitters security. All data transfers are one way.

Nautel transmitters are intelligent, collecting data on nearly every aspect affecting your transmitter's performance. When this data is used by Nautel Customer Service staff for diagnostic purposes it cuts down on repair time and gets you back on air faster.

Nautel Customer Service technicians can use Phone Home to analyze data in real time, even accessing the live AUI, or to view the state of a customer's transmitter at any time leading up to a fault.

This unique diagnostic approach allows Nautel support staff to review the events leading up to and during an alarm occurrence, giving customer service technicians valuable insight into how your transmitter is behaving before, during and after an alarm and how this behavior may be related to the alarm event.

If you are planning to participate in the Nautel Phone Home feature, no pre-installation actions are required. After successfully installing your NV20LT/NV15LT and connecting to the remote AUI, navigate to the User Settings -> Nautel Phone Home page and enter your serial number and email (optional). Nautel will begin to monitor your transmitter's performance.

External Interlock

An external safety interlock is available between:

- pins 19 and 20 on the REMOTE I/O-A 25-pin male D-sub connector (A1J2A) on the rear panel of the controller (A4)
- terminals 19 and 20 on the CUSTOMER CONTROL terminal block (TB3) on the optional remote interface PWB (A16), behind the hinged, front UI panel (see [Figure 1.8.1 on page 1.8.3](#))
- INTLK terminals TB1-1 and TB1-2 of the optional remote interface PWB (A16)

NOTE: If you are using the optional remote interface PWB, use only one of the external interlock options on the PWB, but not both. The remote interface PWB overrides the controller module's interlock circuit.

Any of these connections allow you to connect an external safety interlock circuit that provides an emergency RF inhibit control for the NV20LT/NV15LT. It must present a short circuit (low impedance) between the terminals when the interlock circuit is intact and it is safe to enable the RF output. It must present an open circuit when any interlock switch is activated and the RF output requires inhibition. You can install any number of serial interlock switches.

SECTION 1.9: PARTS AND TOOLS

This section describes parts associated with the NV20LT/NV15LT transmitter, and tools needed during installation and routine operation. Topics include:

- [Parts Supplied by Nautel - see page 1.9.2](#)
- [Parts Not Supplied by Nautel - see page 1.9.2](#)
- [Parts Ordering - see page 1.9.2](#)
- [Module Exchange Program - see page 1.9.3](#)
- [Tools for Installation - see page 1.9.3](#)

Contacting Nautel

You can reach Nautel to order parts or for technical assistance at:

Nautel Limited
10089 Peggy's Cove Road
Hackett's Cove, NS Canada B3Z 3J4
Phone: +1.877.628.8353 (Canada/US)
+1.902.823.5100 (International)

Fax: +1.902.823.3183

Email: support@nautel.com

Web: www.nautel.com

Parts Supplied by Nautel

Ancillary Parts Kit

An ancillary parts kit is shipped with the NV20LT/NV15LT. This kit contains items needed during the installation process. The kit includes toroids, spare fuses, screws and miscellaneous hardware.

Documentation

See “NV20LT/NV15LT Transmitter Manuals” in the “About this Manual” section.

Parts Not Supplied by Nautel

Some parts and materials required to complete installation are not supplied by Nautel. The parts you need vary with the installation requirements. The list of parts you normally provide yourself during installation include:

- A suitable 50 Ω RF output coaxial cable, terminated by the proper connector (e.g., field flange), complete with center male connector (e.g., bullet) at the transmitter end.
- All external control and monitor wiring, including the associated terminating devices, conduit and conduit clamps.
- All electrical power cables, including conduit, terminating devices, and conduit clamps.
- Special tools, if required (e.g., torque wrench).

Parts Ordering

You can order replacement parts from the Customer Service Department, or directly from Nautel through the Nautel website.

Module Exchange Program

Nautel offers a module exchange program for customers who require expedited servicing and replacement of faulty modules. The module exchange program provides immediate replacement of failed modules with refurbished modules.

- The replacement module is shipped to the customer as soon as the customer reports the failure. The customer then returns the failed module to Nautel using the same shipping package.

Tools for Installation

The tools you need during transmitter installation include the following:

- Digital voltmeter (recommend 1000 V, CAT-III rating)
- Phillips screwdrivers, sizes #1 and #2
- Pliers
- Wire cutters
- Panel punch (Greenlee, etc.) for suitable size cable entry hole, as desired
- Hex wrenches (Allen keys)
- Torque wrench with hex adapter, capable of 500 in-lbs (56.5 N-m) (for ac input terminal block)
- Metric and Imperial socket set up to 24 mm (15/16 inch)
- Metric and Imperial wrench set up to 25 mm (1 inch)
- Electrician's knife

SECTION 1.10: PRE-INSTALLATION ASSISTANCE

Nautel provides a number of support options to help you during pre-installation planning and preparation:

- [Pre-installation Consulting](#)
- [Installation and Commissioning Service](#)
- [Online Documentation](#) - see page 1.10.2
- [On-Site Support](#) - see page 1.10.3
- [Training](#) - see page 1.10.3
- [Extended Warranties](#) - see page 1.10.4

Pre-installation Consulting

Nautel field support specialists are available to answer questions and work with you to ensure that your site will be ready for the installation of your NV20LT/NV15LT transmitter. For support, contact Nautel Customer Service and request assistance (see ["On-Site Support"](#) on page 1.10.3).

Installation and Commissioning Service

Nautel offers an installation and commissioning service to customers who want assistance with configuring and commissioning a new Nautel transmitter. After the customer completes the transmitter assembly and installation, Nautel technical personnel will spend up to three days on-site to help make the ac power, RF and remote connections, and to assist with the configuration and testing of Nautel equipment.

The customer is responsible for ensuring that the following stages of installation have been completed, prior to the arrival of Nautel personnel:

- The transmitter has been unpacked, closely checked for any damage caused by shipping, and then assembled.
- Ac power wiring for the transmitter has been installed and connected at the transmitter and at the breaker panel or the building's service entrance.

-
- The customer has prepared the RF coaxial cable – used to connect the transmitter to the antenna – and installed the required connector. The customer has also installed the RF coaxial cable in place and connected it to the antenna and transmitter.
 - Where required, all remote control and monitoring cables have been installed and connected to the station equipment (e.g., modulation monitor, frequency monitor, and power meter).
 - The site has been made ready for the equipment, and adequate protection against lightning and lightning-induced transients has been provided.
 - The following test equipment has been made available at the site:
 - ❖ Two-channel oscilloscope (with probes)
 - ❖ Audio signal generator
 - ❖ Distortion analyzer
 - ❖ Modulation monitor
 - ❖ Frequency counter
 - ❖ 50 Ω test load (rated for 150% of carrier power, VSWR less than 1.1:1)

Nautel's service representative takes full responsibility for commissioning the transmitter, validating all external interfaces (i.e., the ac supply, RF output, remote control and monitoring equipment) and checking out the equipment prior to activation. The service representative turns on the transmitter, performs all adjustments and set-up procedures, and carries out proof of performance tests at the site. These tests ensure that the transmitter is operating normally in compliance with its specifications. The service representative also provides a demonstration and a short explanation of the operation of the transmitter. Finally, the customer signs an Acceptance of Installation Certificate that provides feedback to Nautel regarding the commissioning service.

Online Documentation

Nautel provides documentation online to customers, letting you familiarize yourself with specifications, operation, maintenance and troubleshooting prior to the delivery of your equipment.

- Documentation is also provided on USB and delivered with the transmitter.

On-Site Support

If you require on-site assistance, Nautel's field support specialists can help you prepare your site, and ensure that your NV20LT/NV15LT transmitter installation can proceed as quickly as possible. For more information about on-site support, including scheduling and pricing, contact Nautel Customer Service:

- Telephone: +1.902.823.5100
- Fax: +1.902.823.3183
- Email: support@nautel.com

After business hours (Atlantic time or Eastern time in North America), requests sent by fax or email will be acknowledged within one working day.

Training

Nautel's SBE-certified broadcast training programs satisfy your day-to-day knowledge requirements. Students participating in Nautel's broadcast transmitter or RF basics training programs earn one SBE credit for each completed day of training. Nautel's comprehensive selection of training programs will help a customer's staff develop valuable skill sets, reduce downtime, and make the most of the customer's technology investment.

Nautel training programs are made up of individual modules that can be mixed and matched to meet the customer's specific training needs. All Nautel training courses are available at the Nautel Training Center. Training can also be provided at the customer's facility, for training the customer's technical staff on the customer's transmitter.

All Nautel training courses combine classroom and hands-on laboratory work to ensure a balanced learning experience. Many of our classes also include diagnostic lab exercises.

Nautel training courses feature:

- Limited class sizes to ensure maximum student participation and access to equipment
- Emphasis on need-to-know, day-to-day knowledge
- Labs that focus on the tasks most often performed at the transmitter site

On-Site or Factory Training

This includes product overview, site and pre-installation, theory of operation, testing and adjustments, operating instructions, system-level troubleshooting, component-level troubleshooting, component parts lists, and wiring route sheets.

Extended Warranties

Nautel's standard four-year warranty provides excellent coverage and satisfies most customers' needs. However, if you want extended coverage, Nautel offers one- and two-year Extended Warranty Plans to cover electrical and mechanical repairs or replacements for all Nautel equipment.

Coverage

The Extended Warranty Plan includes:

- A module exchange program for many common modules and circuit boards (North America only)
- Toll-free hotline (North America only)
- Necessary labor performed by Nautel authorized personnel to repair the product to meet factory specifications
- Necessary components
- Modifications to correct performance problems
- Return shipping

Details

Extended Warranty Plans must be purchased prior to the expiration of the original four-year warranty.

One-year Extended Warranty Plans add an additional year (12 months) of coverage after the end of the customer's standard four-year warranty. The two-year plan adds an additional two years (24 months).

Only repairs done at Nautel's facilities or by Nautel authorized personnel will be covered by the Extended Warranty Plans.

You must ship faulty products back to Nautel, prepaid, and in the original package or in a package that provides equivalent protection.

Nautel can choose to repair or replace equipment.

Purchasing a One-Year or Two-Year Extended Warranty Plan

If the transmitter is still covered by its original four-year warranty period, you can contact Nautel by telephone, fax, mail, or email with the model number, serial number and date of purchase.

Once you purchase a Nautel Extended Warranty Plan, you receive an extended warranty plan certificate, plan number, and a toll-free number (North America only) to call for any service-related issues.

Using the Extended Warranty Plan

Contact Nautel's Canadian or U.S. service facility by phone, fax, or email as soon as a problem occurs. The following will be required when contacting Nautel:

- Extended warranty plan number
- Product model number
- Serial number
- Brief description of the problem

If Nautel's service technicians are unable to solve the problem over the telephone, Nautel will give you an RMA number. You then return the module or circuit board to a Nautel service facility, so that Nautel can provide a replacement. Do not ship a component back to Nautel until you have an RMA number.

SECTION 1.11: LIST OF TERMS

This section defines some of the terms that are used in Nautel documentation.

AES/EBU. Audio Engineering Society/European Broadcasting Union (AES/EBU) is the name of a digital audio transfer standard. The AES/EBU digital interface is usually implemented using 3-pin XLR connectors (the same type connector used in professional micros). One cable carries both left-channel and right-channel audio data to the receiving device.

AUI. The Advanced User Interface is the local touch screen on the front door and the advanced remote control/monitoring feature that allows for extensive remote control and monitoring of the transmitter.

CUTBACK. A reduction in RF output power, caused by the occurrence of multiple shutbacks within a pre-defined period.

DHCP. Dynamic Host Carrier Protocol.

DSP. Digital Signal Processing.

EEPROM. Electrically Erasable Programmable Read-Only Memory.

FOLDBACK. A reduction in RF output power, caused by adverse load conditions (high VSWR). No shutbacks or cutbacks have occurred.

LED. Light Emitting Diode (also referred to as lamp).

LVPS. Low Voltage Power Supply. A module or modules used in the ac-dc power stage that generates the low level dc supply voltage for the transmitter.

PRESET. A setting that controls power level, frequency and audio parameters. The NV20LT/NV15LT allows you to pre-program multiple presets.

PWB. Printed Wiring Board.

SHUTBACK. A complete, but temporary loss of RF output power, caused by any one of a variety of faults, including high VSWR, high reject load power, RF drive failure, or an open external interlock.

SHUTDOWN. A complete and permanent loss of RF output power. Typically follows repeated cutback, foldback or shutback events.

SURGE PROTECTION PANEL. An electrical panel that protects equipment from electrical surges in the ac power supply, antenna or site ground caused by lightning strikes.

UI. The User Interface is the controller module's front panel LCD screen that allows for extensive local control and monitoring of the transmitter.

VSWR. Voltage standing wave ratio. This is an expression of the ratio of reverse voltage to forward voltage on the feedline and antenna system. An ideal VSWR of 1:1 provides maximum transmitter-antenna efficiency.

NV20LT/NV15LT PRE-INSTALLATION MANUAL

Document: NHB-NV15LT-NV20LT-PRE

Issue: 2024-05-01

Nautel Limited

10089 Peggy's Cove Road
Hackett's Cove, NS Canada B3Z 3J4

Toll Free: +1.877.6NAUTEL (662.8835)
(Canada & USA only) or

Phone: +1.902.823.3900 or

Fax: +1.902.823.3183

Nautel Inc.

201 Target Industrial Circle
Bangor, Maine USA 04401

Phone: +1.207.947.8200

Fax: +1.207.947.3693

Customer Service (24-hour support)

+1.877.628.8353 (Canada & USA only)

+1.902.823.5100 (International)

Email: support@nautel.com

Web: www.nautel.com

© Copyright 2024 NAUTEL. All rights reserved.

